

TM 11-6625-351-12

DEPARTMENT OF THE ARMY TECHNICAL MANUAL

OPERATOR AND ORGANIZATIONAL MAINTENANCE MANUAL

RADIO INTERFERENCE MEASURING SET AN/URM-85

This copy is a reprint which includes current pages from Changes 1,3,4 and 5.

HEADQUARTERS, DEPARTMENT OF THE ARMY
7 JULY 1961

WARNING

DANGEROUS VOLTAGES EXIST IN THIS EQUIPMENT

Be careful not to contact high-voltage connections or 120/240-volt input connections when working on or near this equipment. Serious electrical shock or death may result from contact with these terminals.

DON'T TAKE CHANCES !

RADIATION HAZARD

Tube types OA2WA and OB2WA contain a small amount of radioactive material. These tubes are potentially hazardous when broken. Contact qualified medical personnel immediately in case of an accidental cut from a broken OA2WA or OB2WA. For further instructions, refer to TB SIG 225.

CHANGE

No. 5

HEADQUARTERS
DEPARTMENT OF THE ARMY
WASHINGTON, D.C., 30 July 1976

**Operator and Organizational Maintenance Manual
RADIO INTERFERENCE MEASURING SET AN/URM-85**

TM 1143625-351-12, 7 July 1961, is changed as follows:

Page 5. Paragraphs 2b and c are superseded as follows:

b. Report of Packaging and Handling Deficiencies. Fill out and forward DD Form 6 (Packaging Improvement Report) as prescribed in AR 700-58/AFR 71-13, and DSAR 41458.

c. Discrepancy in Shipment Report (DISREP) (SF 361). Fill out and forward Discrepancy in Shipment Report (DISREP) (SF 361) as prescribed in AR 55-38/AFR 75-18, and DSAR 4500.15.

Paragraph 2.1, line 7. "AMSEL-MA-C" is changed to read "DRSEL-MA-Q."

Page 8, figure 5. "Rod, Ground GP-117/URM-7" is deleted.

Page 12, paragraph 5a. Delete item seventeen in its entirety.

Page 13, paragraph 6. Delete last item in its entirety.

Page 18, paragraph 11i is rescinded.

Page 81, appendix I. Add the following:

TM 1145625-299-15 Operator, Organizational,
Field and Depot
Maintenance Manual:
Signal Generators
AN/URM-64M and AN/
URM-64A.

Page 84, appendix II, section II. In tools required column, after overhaul function for AN/URM-85, add: "15."

Page 87, appendix II, section III. Add the following. In column 1, "Signal Generator AN/URM-64," in column 6, "X," in column 7, "15."

By Order of the Secretary of the Army:

FRED C. WEYAND
General, United States Army
Chief of Staff

Official:

PAUL T. SMITH
Major General, United States Army
The Adjutant General

Distribution:

Active Army

| | |
|-------------------------|------------------------------|
| USASA (2) | MAAG (1) |
| COE (1) | USARMIS (1) |
| TSG (1) | USAREUR (10) |
| USAARENBD (1) | MAAG, Republic of China (2) |
| DARCOM (1) | Installation (2) except |
| TRADOC (2) | Fort Carson (5) |
| OS Maj Comd (4) | Fort Gillem (10) |
| LOGCOMDS (3) | Fort Gordon (10) |
| MICOM (2) | Fort Huachuca (10) |
| TECOM (2) | Ft Richardson (ECOM Ofc) (2) |
| USACC-CONUS (2) | LBAD (14) |
| USACC-EUR (2) | SAAD (30) |
| USACC-PAC (2) | TOAD (14) |
| USACC-A (2) | SHAD (10) |
| USACC-SO (2) | SigFLDMS (1) |
| USACC-T (2) | USAERDAA (1) |
| USACC (4) | USAERDAW (1) |
| MDW (1) | Units org under fol TOE: (1) |
| Armies (2) | 11-16 |
| Corps (2) | 11-97 |
| HISA (Ft Monmouth) (33) | 11-98 |
| Svc Colleges (1) | 11-117 |
| USASESS (5) | 11-302 |
| USAADS (2) | 11-500(AA-AC) |
| USAFAS (2) | 29-134 |
| USAAARMS (2) | 29-136 |
| USAIS (2) | 30-25 |
| USAES (2) | 30-29 |
| USAICS (3) | 55-458 |

NG: None

USAR: None

For explanation of abbreviations used see, AR 310-50

CHANGE }
No. 4 }

HEADQUARTERS
DEPARTMENT OF THE ARMY
WASHINGTON, DC, 29 August 1975

**Operator and Organizational Maintenance Manual
RADIO INTERFERENCE MEASURING SET AN/URM-85**

TM 11-6625-351-12, 7 July 1961, is changed as follows:

Page 9, figure 6. The caption is changed to read "Running spares."

Page 13, paragraph 5.1. In the twelfth item "CV-112/URM-85: 20 mHz" is changed to read "CV-1103/URM-85: 200 mHz."

Add "NSN 5950-00-566-3753, 1, Transformer, Power, Isolation and Step-Down TF-248G, Fig. No.: 5" to the list in the proper columns.

Page 14, figure 7. The caption is changed to read "Converters, Frequency, Electronic CV-1101/URM-85, CV-110/URM-85, and CV-110/URM-85, with Case, Electronic Frequency Converter CY-3092/URM-85."

Page 87, section III. Make the following

changes:

Change "Generator, Pulse (Empire Devices Model IG-115)" to read "Generator, Signal AN/URM-127."

In the Remarks column, delete "To be nomen and std."

Change "Oscilloscope AN/USM-50" to read "Oscilloscope AN/USM-281A."

Change "Signal Generator TS-497/URR" to read "Signal Generator AN/USM-44(*)/U."

Change TK-87/U" to read "TK-100/G."

Change "TK-88/U" to read "TK-105/G."

Page 88, appendix 111, section II. Delete the sixth item in its entirety.

By Order of the Secretary of the Army:

Official:

VERNE L. BOWERS
*Major General, United States Army
The Adjutant General*

FRED C. WEYAND
*General, United States Army
Chief of Staff*

Distribution:

Active Army:

USASA (2)
Dir of Trans (1)
COE (1)
TSG (1)
USAAARENBD (1)
AMC (1)
MICOM (2)
TECOM (2)
TRADOC (2)
ARADCOM (2)
ARQDCOM Rgn (2)
OS Maj Comd (4) except
 USAREUR (10)
LOGCOMD (3)
USACC (4)
USACC-CONUS (2)
USACC-EUR (2)
USACC-PAC (2)
USACC-AL (2)
USACC-SO (2)
USASTRATCOM-T (2)
MDW (1)
Armies (2)
Corps (2)
HISA (Ft Monmouth) (43)
Ft Gillem (10)
Ft Gordon (10)
Ft Huachuca (10)
Ft Carson (ECOM Ofc) (2)
Svc Colleges (1)
USASESS (5)
USAINTCS (3)
USAADS (2)

USAFAS (2)
USAARMS (2)
USAIS (2)
USAES (2)
AD (1) except
 SAAD (30)
 LBAD (14)
 TOAD (14)
 SHAD (3)
USA Dep (2)
Sig Sec USA Dep (2)
Sig Dep (2)
ATS (1)
MAAG (1) except
 MAAG, Republic of China (2)
WRAMC (1)
USARMIS (1)
USAERDAA (1)
USAERDAW (1)
Sig FLDMS (1)
Units org under fol "OE (1 ea.):
 11-16
 11-97
 11-98
 11-117
 11-302
 11-500(AA-AC)
 29-134
 29-136
 30-25
 30-29
 55-458

ARNG & USAR: None.

CHANGE }
No. 3 }

HEADQUARTERS,
DEPARTMENT OF THE ARMY
WASHINGTON, D. C., 24 July 1974

Operator and Organizational
Maintenance Manual
RADIO INTERFERENCE MEASURING SET
AN/URM-85

TM 11-6625-351-12, 7 July 1961, is changed as follows:
Page 5. Delete paragraph 1.1 and substitute:

1.1. Indexes of Publications

a. DA Pam 310-4. Refer to the latest issue of DA Pam 310-4 to determine whether there are new editions, changes, or additional publications pertaining to the equipment.

b. DA Pam 310-7. Refer to DA Pam 310-7 to determine whether there are modification work orders (MWO's) pertaining to the equipment.
Paragraph 2. Delete paragraph 2 and substitute:

2. Forms and Records

a. Reports of Maintenance and Unsatisfactory Equipment. Maintenance forms, records, and reports which are to be used by maintenance personnel at all maintenance levels are listed in and prescribed by TM 38-750.

b. Report of Packing and Handling Deficien-

cies. Fill out and forward DD Form 6 (Report of Packaging and Handling Deficiencies) as prescribed in AR 700-58/NAVSUP PUB 378/AFR 71-4/MCO P4030.29, and DSAR 4145.8.

c. Discrepancy in Shipment Report (D ISREP) (SF 361). Fill out and forward Discrepancy in Shipment Report (DISREP) (SF 361) as prescribed in AR 55-38/NAVSUPINST 4610.33/AFM 75-18/MCO P4610.19A, and DSAR 4500.15.
After paragraph 2 add:

2.1. Reporting of Errors

The reporting of errors, omissions, and recommendations for improving this publication by the individual user is encouraged. Reports should be submitted on DA Form 2028 (Recommended Changes to Publications and Blank Forms) and forwarded direct to Commander, US Army Electronics Command, ATTN: AMSEL-MA-C Fort Monmouth, NJ 07703.

Page 13. After paragraph 5 add:

5.1. Items Comprising an Operable Equipment

| FSN | QTY | Nomenclature, part No. and mfr code | Fig. No |
|---------------|-----|---|---------|
| | | Radio Interference Measuring Set AN/URM-85 which includes: | |
| 6625-731-7906 | 1 | Antenna AS-1158/URM-85: cone type; 150 kHz to 1000 mHz freq range; pedestal mtd; omnidirectional; mounts on reflector for use. | 4 |
| 6625-752-6098 | 1 | Antenna AT-1026/URM-85: loop ant; 150 kHz to 30 mHz freq range; rotating type; pedestal mtd | 3 |
| 6625-752-6097 | 1 | Antenna AT-1030/URM-85: straight dipole; 400 mHz to 1000 mHz freq range; incl corner reflector for 10 db gain increase; pedestal mtd; fixed | 1 |

*This Change supersedes Change 2, 18 May 1964.

| FSN | QTY | Nomenclature, part No., and mfr code | Fig No |
|---------------|-----|--|--------|
| 6625-752-6094 | 2 | Antenna Element AT-1028/URM-85: dipole arm; resonates over 200 mHz 400 mHz range cylindrical; 1 end threaded; 0.295 in. dia x 6-1/8 in. lg; extends to 14-7/8 in. lg | 4 |
| 6625-752-6096 | 2 | Antenna Element AT-1029/URM-85: dipole arm; resonates over 78 mHz to 220 mHz range cylindrical; 1 end threaded; 1/2 in. dia x 12-1/4 in. lg; extends to 42-1/8 in. lg | 4 |
| 5905-731-7922 | 1 | Attenuator, Fixed CN-721/URM-85: resistive type; 50 ohm imped; 2 w; 150 kHz to 1000 mHz freq response; 40 db + 1/2 db; 2 connectors; 3/5 in. lg x 13/16 in. dia | 5 |
| 5995-753-2210 | 1 | Cable Assembly, Power, Electrical CX-6680/U (6 ft): 600 v; 3 cond; 1 plug on ea end; alligator clip on 1 end | 5 |
| 6625-731-7915 | 1 | Cable Assembly, Special Purpose, Electrical, Branched CX-6681/URM-85; 2 ft 6 in. lg o/a | 5 |
| 6625-753-2166 | 1 | Cable Assembly Set, Electrical MX-3410/URM-85: color coded green and red; one cable feeds output of impulse gen from receiver to ant.; other cable feeds incoming RF signal to receiver input | 5 |
| 5820-752-6102 | 1 | Converter, Frequency, Electronic CV-1101/URM-85: 150 kHz to 30 mHz incoming freq range; 455 kHz to 1.6 mHz resultant freq range; 6.3 v, 50 to 400 Hz, 1 ph; 18.5 v, 150 v dc; 50 ohm input, 200 ohm output; 6 bands, 14-1/8 in. lg x 9-1/16 in. wd x 9 in. h o/a | 6 |
| 5820-752-6103 | 1 | Converter, Frequency, Electronic CV-1102/URM-85: 20 mHz to 220-mHz incoming freq range; 10.7 mHz resultant freq; 6.3 v, 50 to 400 Hz, 1 ph; 18.5 v, 105 v, 150 v dc; 50 ohm input, 200 ohm output; 2 bands, 14-1/8 in. lg x 9-1/16 in. wd x 9 in. h o/a | 2 |
| 5820-752-6104 | 1 | Converter, Frequency, Electronic CV-1102/URM-85: 20 mHz to 400 mHz incoming freq range; 30 mHz resultant freq; 6.3 v, 50 to 0 400 Hz, 1 ph; 18.5 v, 105 v, 150 v dc; 5 ohm input, 200 ohm output; 1 tuneable band; 14-1/8 in. lg x 9-1/16 in. wd x 9 in. h o/a | 6 |
| 5820-752-6105 | 1 | Converter, Frequency, Electronic CV-1104/URM-85: 400 mHz to 1000 mHz incoming freq range; 42 mHz resultant freq; range; 6.3 v, 50 to 400 Hz, 1 ph; 18.5 v, 105 v, 150 v; 50 ohm input, 200 ohm output; 2 bands; 14-1/8 in. lg x 9-1/16 in. wd x 9 in. h o/a | 6 |
| 6625-752-6099 | 1 | Coupler, Antenna CU-890/URM-85: 150 kHz to 30 mHz in. 6 bands; transformer coupling; 1 w max; variable tuning; 2 connector type, 8-1/2 in. lg x 5 in. dia | 3 |
| 5995-196-9564 | 2 | Cord Assembly, Electrical: 2 cond, stranded; tp plug one end, to jack other end; 5 ft 10-13/32 in. lg o/a; MIL type CD-307-A | 5 |
| 6625-557-7475 | 1 | Cord Assembly, Electrical CD-307 (30 ft): 2 cond, stranded; tp plug one end, tp jack other end; 30 ft lg o/a; MIL type CD-307-A | 5 |
| 6625-557-8632 | 1 | Cord Assembly, Electrical CX-4305/U (30 ft): f/remote meter | 5 |
| 6625-752-6100 | 1 | Coupler, Antenna CU-893/URM-85: transformer coupling; 20 mHz to 200 mHz freq range; 1 w max; transforms balanced line; accom 2 dipole ant. elements; pedestal mtd; 24-1/8 in. lg x 3-1/8 in. lg x 3-1/8 in. wd x 2-3/4 in. d | 4 |
| 6625-752-6101 | 1 | Coupler, Antenna CU-894/URM-85: transformer coupling; 200 to 400 mHz freq range; 1 w max; transforms balanced line to unbalanced line; accom 2 dipole ant. elements; pedestal mtd; 24-1/8 in. lg x 3-1/8 in. cd x 2-3/4 in. d o/a | 4 |
| 6625-731-7910 | 1 | Coupler, Antenna CU-895/URM-85: resistive coupling; 150 kHz to 1000 mHz freq range; 1 w max; fixed tuning; 3 connectors, 3-3/4 in. lg x 3-1/4 in. wd x 1-1/4 in. h o/a | 4 |

| FSN | QTY | Nomenclature, part No., and mfr code | FIG. No. |
|---------------|-----|--|----------|
| 6625-731-7912 | 1 | Coupler, Radio Frequency Interference CU-891/URM-85: u/w 150 kHz to 300 MHz freq range; couples rf energy from 50 ohm transmission line to AN/URM-85 input; incl 2 ea connector UG-58A/U and 2 bind posts; 2-1/2 in. lg x 2-3/8 in. dia | 3 |
| 6625-731-7911 | 1 | Coupler, Radio Frequency Interference CU-892/URM-85: used w/150 kHz to 30 MHz freq range: couples rf energy from 500 ohm transmission line to AN/URM-85 input; incl 2 connectors UG-58A/U and 2 bind posts; 2-1/2 in. lg x 2-3/8 in. dia | 3 |
| 6625-731-7916 | 1 | Coupler, Radio Frequency Interference CU-896/URM-85: couples rf energy from 50 ohm transmission lines to AN/URM-85 input; used in 20 MHz to 1000 MHz freq range; 1 conn, 2 bind posts; 2-1/2 in. lg x 2-3/8 in. dia | 4 |
| 6625-731-7917 | 1 | Coupler, Radio Frequency Interference CU-897/URM-85: couples rf energy from 500 ohm transmission lines to AN/URM-85 input; 20 MHz to 1000 MHz freq range; incl 1 conn, 2 bind posts; 2-1/2 in. lg x 2-3/8 in. dia | 4 |
| 5965-504-6370 | 1 | Headset, Electrical H-113/U | 5 |
| | 4 | Leg, Case: telescoping leg u/w case, Receiver CY-3093/URM-85; alum; 1-1/8 in. dia x 24 in. lg; extends to 31 in. lg ++L1Se14-437 | 1 |
| 5820-228-0244 | 12 | Mast Section AB-21/GR | 5 |
| 6625-731-7914 | 1 | Multimeter, Remote ME-204/URM-85: upper scale -6 to +20 db, lower scale 0 to 10 mv; for use up to 30 ft from end item equip; c/o meter, connector, tp jack incl alum housing | 5 |
| 6625-753-2157 | 1 | Probe, Electrical Field Interference Measuring MX-3411/URM-85: 150 kHz to 1000 MHz freq range; 50 ohm; 8 in. lg x 7/8 in. dia | 5 |
| 6625-753-2156 | 1 | Probe, Magnetic Field, Interference Measuring MX-3412/URM-85: 20 MHz to 1000 MHz freq range; 50 ohm; 1 female connector; 9 in. lg x 3-3/8 in. dia | 4 |
| 6625-753-2155 | 1 | Probe, Magnetic Field, Interference Measuring MX-3409/URM-85: 150 kHz to 30 MHz 50 ohm; vinyl jacket covering; 1 female connector; 9 in. lg x 3-3/8 in. dia | 3 |
| 5820-752-6108 | 1 | Receiver, Radio R-1040/URM-85: 150 kHz to 1000 MHz 11 bands; 600 ohm impeded; 115 v or 230 v, 50 to 400 Hz, 1 ph. accom 1 of 4 converters; 21-3/8 in. lg x 15-3/4 in. d x 10-3/16 in. h | 2 |
| 6625-752-6095 | 1 | Reflector, Antenna AT-1027/URM-85: plane type; u/w cone ant. and vert ant. coupler units; mts on tripod base; 24 in. lg x 24 in. wd x 1-1/4 in. h o/a | 4 |
| 6625-731-7907 | 1 | Tripod, Antenna MT-2459/URM-85: mts ant or ant feflectors; incl 3 mast sect; has 3 adj wooden legs; 5-1/2 in dia x 3 ft lg; extends to 5 ft lg | 1 |

Page 81, appendix L After the last reference, add:

TB SIG 286 Headset H-113/U.
 TM 11-5965-231-14P operator's, organizational, direct support, and general support maintenance repair parts and special

tools lists (including depot maintenance repair parts and special tools): Headset, electric H-113/U FSN 5965-504-6370.

Page 88. Delete appendix III and substitute:

APPENDIX III

BASIC ISSUE ITEMS LIST (BIIL) AND ITEM TROOP INSTALLED OR AUTHORIZED LIST (ITIAL)

Section I. INTRODUCTION

1. Scope.

This appendix lists basic issue items and items troop installed or authorized required by the crew/operator for installation, operation, and maintenance of Radio Interference Measuring Set AN/URM-85.

2. General.

This Basic Issue Items and Items Troop Installed or Authorized List is divided into the following sections:

a. Basic Issue Items List-Section II. A list, in alphabetical sequence, of items which are furnished with, and which must be turned in with the end item.

b. Items Troop Installed or Authorized List-Section III. A list, in alphabetical sequence of items which, at the discretion of the unit commander, may accompany the end item, but are not subject to be turned in with the end item.

3. Explanation of Columns.

The following provides an explanation of columns found in the tabular listings:

a. Illustration. This column is divided as follows:

(1) *Figure Number.* Indicates the figure number of the illustration in which the item is shown.

(2) *Item Number.* Not applicable.

b. Federal Stock Number. Indicates the Federal stock number assigned to the item and will be used

for requisitioning purposes.

c. Part Number. Indicates the primary number used by the manufacturer (individual, company, firm, corporation, or Government activity), which controls the design and characteristics of the item by means of its engineering drawings, specifications standards, and inspection requirements, to identify an item or range of items.

d. Federal Supply Code for Manufacturer (FSCM). The FSCM is a 5-digit numeric code used to identify the manufacturer, distributor, or Government agency, etc., and is identified in SB 708-42.

e. Description. Indicates the Federal item name and a minimum description required to identify the item.

f. Unit of Measure (U/M). Indicates the standard of basic quantity of the listed item as used in performing the actual maintenance function. This measure is expressed by a two-character alphabetical abbreviation, (e.g., ea, in, pr, etc.). When the unit of measure differs from the unit of issue, the lowest unit of issue that will satisfy the required units of measure will be requisitioned.

g. Quantity Furnished with Equipment (Basic Issue Items Only). Indicates the quantity of the basic issue item furnished with the equipment.

h. Quantity Authorized (Items Troop Installed or Authorized Only). Indicates the quantity of the item authorized to be used with the equipment.

(Next printed page is 6)

SECTION II. BASIC ISSUE ITEMS LIST

| (1) ILLUSTRATION | | (2) FEDERAL STOCK NUMBER | (3) PART NUMBER | (4) FSCM | (5) DESCRIPTION USABLE ON CODE | (6) UNIT OF MEAS | (7) QTY FURN WITH EQUIP |
|---------------------|--------------------|-----------------------------------|-----------------------|-------------|--|---------------------------|-------------------------------------|
| (A) FIG. NO. | (B) ITEM NO. | | | | | | |
| 5 | | 6625-731-7908 | | | BAG, CANVAS CW-572/URM-85, ACCOM TRIPOD, ANTENNA MT-2459/URM-85; HAS ADJ SHOULDER STRAP, 7 IN. DIA X 45 IN. LG | EA | 1 |
| | | 5820-472-1045 | | | CASE, ELECTRONIC FREQUENCY CONVERTER CY-3092/URM-85, ACCOM CONVERTER, FREQUENCY ELECTRONIC, AIR VALVE AND HANDLE ON TOP, 12-1/4 IN. LG X 12-1/2 IN. WD X 16-7/8 IN. H | EA | 3 |
| 3 | | 6625-753-2167 | | | CASE, RADIO INTERFERENCE, MEASURING SET GROUP CY-3094/URM-85, ACCOM 1 EA ANTENNA AT-1026/URM-85, 1 EA COUPLER, ANTENNA CU-890/URM-85, 1 EA PROBE MX-3409/URM-85, 1 EA COUPLER CU-891/URM-85, 1 EA COUPLER CU-892/URM-85; 1 HANDLE AND 1 AIR VALVE ON TOP, 23-7/8 IN. LG X 8-1/8 IN. WD X 15-1/4 IN. H O/A | EA | 1 |
| | | 6625-753-2208 | | | CASE, RADIO INTERFERENCE MEASURING SET GROUP CY-3095/URM-85, ACCOM ANTENNA, COUPLERS, ANTENNA ELEMENTS, MAST SECT, CORD ASSYS, CABLE ASSYS, MULTIMETERS, MEASURING TAPE, RULER, ATTENUATOR, HEADSETS, GROUND RODS, TRANSFORMER, PROBES, ALIGNMENT TOOL, SOCKET, HEAD SCREW, 26-5/8 IN. LG X 26-5/8 IN. WD X 16-7/8 IN. H O/A | EA | 1 |
| 1 | | 5820-752-6106 | | | CASE, RECEIVER CY-3093/URM-85, ACCOM RECEIVER, RADIO R-1040/URM-85; HANDLE EA SIDE, AIR VALVE 1 SIDE, ACCOM 4 LEGS, 27-1/2 IN. LG X 12-1/2 IN. WD X 10-3/8 IN. H O/A | EA | 1 |
| 5 | | 5975-578-4777 | | | ROD, GROUND GP-117/URM-7, W/HANDLE; 12 IN. LG X 3/8 IN. DIA O/A | EA | 1 |
| | | 6625-735-6476 | | | TRAY, ACCESSORY, ALUM, W/HINGED COVER, ACCOM 1 GND ROD, 4 KEYS, SOCKET HEAD SCREW IN COVER AND 1 FIXED ATTENUATOR, 2 ANTENNA ELEMENTS, 1 STEEL TAPE, 3 COUPLERS, 2 PROBES, 1 RULER, 1 ALIGNMENT TOOL IN BOTTOM UNIT 13 IN. LG X 9/14 IN. D X 3-1/8 IN. H O/A | EA | 1 |

TM 11-6625-351-12
SECTION III. ITEMS TROOP INSTALLED OR AUTHORIZED LIST

| (1) FEDERAL STOCK NUMBER | (2) PART NUMBER | (3) FSCM | (4) DESCRIPTION USABLE ON CODE | (5) UNIT OF MEAS | (6) QTY AUTH |
|-----------------------------------|-----------------------|-------------|--|---------------------------|--------------------|
| 6625-732-4092 | | | ALIGNMENT TOOL, 2 WORKING ENDS, SS, 4-3/8 IN. LG X 3/8 IN. ACROSS FLATS, EMPIRE DEVICES PART NO. A-6498 KEY, SOCKET HEAD SCREW, HEX, "L" HANDLE, 3/64 IN. ACROSS HANDLE, 1-9/16 IN. LG X 15/32 IN. D, FED TYPE I. CLASS A ++L1SE14-425 KEY, SOCKET HEAD SCREW, HEX, "L" HANDLE, 1/16 IN. ACROSS FLATS, 1-21/32 IN. LG X 15/32 IN. D, FED TYPE I, CLASS A ++L1SE14-426 KEY, SOCKET HEAD SCREW, HEX, "L" HANDLE, 5/64 IN. ACROSS FLATS, 1-25/32 IN. LG X 33/64 IN. D, FED TYPE I, CLASS A ++L1SE14-427 KEY, SOCKET HEAD SCREW, HEX, "L" HANDLE, 3/32 IN. ACROSS FLATS, 1-29/32 IN. LG X 9/16 IN. D, FED TYPE I, CLASS A ++L1SE14-428 | EA | 1 |
| 7510-732-1642 | D-3895 | | RULER, PLASTIC, CALIBRATIONS ON 1 SIDE INDICATE CORRECT LG OF DIPOLE ARMS FOR DESIRED FREQ, OTHER SIDE INDICATES SPACING REQUIRED BETWEEN DIPOLE AND REFLECTOR, 12 IN. LG X 1-3/8 IN. WD, EMPIRE DEVICES | EA | 1 |
| | A-6277 | | TAPE, MEASURING, STEEL, GRADUATED IN UNITS OF MEGAHERTZ FROM 17 MHZ THRU 400 MHZ, HAND CRANK REWIND, 1/2 IN. WD TAPE, MEASURES DIPOLE ARM FREQ, EMPIRE DEVICES ++L1SE14-33 | EA | 1 |

By Order of the Secretary of the Army:

CREIGHTON W. ABRAMS
General, United States Army
Chief of Staff

Official:

VERNE L. BOWERS
Major General, United States Army
The Adjutant General

Distribution:

Active Army:

| | |
|-------------------------------|--------------------------------|
| USASA (2) | USASESS (5) |
| CNGB (1) | AD (1) except |
| TSG (1) | SAAD (30) |
| ACSC-E (2) | TOAD (14) |
| USAMB (10) | LBAD (10) |
| USAARENBD (1) | ATAD (10) |
| TRADOC (2) | USA Dep (1) |
| MAC (1) | Sig Sec USA Dep (2) |
| MICOM (1) | Sig Dep (2) |
| TECOM (2) | ATS (1) |
| ARADCOM (2) | USAERDAA (1) |
| ARADCOM Rgn (1) | USAERDAW (1) |
| OS Maj Comd (2) except | USACC Telecon Cen (2) |
| USAREUR (10) | MAAG, Republic of China (2) |
| USACC (2) | Taiwan Defense Comd (2) |
| USACC-CONUS (2) | Units org under fol TOE: 1 ea. |
| USACC-EUR (2) | 11-16 |
| USACC-PAC (2) | 11-57 |
| USACC-Alaska (2) | 11-97 |
| USACC-South (2) | 11-98 |
| USASTRATCOM-T (2) | 11-117 |
| HISA (Ft Monmouth) (18) | 11-500(AA-AC) |
| Armies (1) | 29-134 |
| Ft Huachuca (5) | 29-136 |
| Ft Carson (5) | 29-500 |
| Ft Richardson (ECOM Ofc) (1) | 30-25 |
| WSMR (1) | 30-29 |
| Svc Colleges (1) | 55-158 |

ARNG: State AG-AL, CA, CT, IL, IA, MS, MO, NJ, OH, TN, TX, VA (3 cys ea)

USAR: None.

For explanation of abbreviations used, see AR 310-50.

TECHNICAL MANUAL
Operator and Organizational Maintenance Manual
RADIO INTERFERENCE MEASURING SET AN/URM-85

TM 11-6625-351-12 }
CHANGES No. 1 }

HEADQUARTERS,
DEPARTMENT OF THE ARMY
WASHINGTON, D. C., 13 September 1963

TM 116625-351-12, 7 July 1961, is changed as follows:

Page 5. Add paragraph 1.1 after paragraph 1.

1.1 Index of Publications

Refer to the latest issue of DA Pam 310-4 to determine whether there are new editions, changes, or additional publications pertaining to your equipment. DA Pam 310-4 is an index of current technical manuals, technical bulletins, supply bulletins, lubrication orders, and modification work orders that are available through publications supply channels. The index lists the individual parts (-10, -20, -35P, etc) and the latest changes to and revisions of each equipment publication.

Delete paragraph 2 and substitute:

2. Forms and Records

a. Reports of Maintenance and Unsatisfactory Equipment. Use equipment forms and records in accordance with instructions in TM 38-750.

b. Report of Damaged or Improper Shipment. Fill out and forward DD Form 6 (Report of Damaged or Improper Shipment) as prescribed in AR 700-58 (Army), NAVSANDA Publication 378 (Navy), and AFR 71-4 (Air Force).

c. Reporting of Equipment Manual Improvements. The direct reporting by the individual user of errors, omissions, and recommendations for improving this manual is authorized and encouraged. DA Form 2028 (Recommended changes to DA technical manual parts lists or supply manual 7, 8, or 9) will be used for reporting these improvements. This form will be completed in triplicate using pencil, pen, or typewriter. The original and one copy will be forwarded direct to: Commanding Officer, U.S. Army Electronics Materiel Support Agency, ATTN: SELMS-MP, Fort Monmouth, N.J. One information copy will be furnished to the indi-

vidual's immediate supervisor (e.g., officer, noncommissioned officer supervisor, etc).

Page 56. Delete paragraphs 33 and 34 and substitute:

33. Scope of Operators Maintenance

The maintenance duties assigned to the operator of Radio Interference Measuring Set AN/URM4 are listed below together with a reference to the paragraphs covering the specific maintenance function. The duties assigned do not require tools or test equipment other than those issued with the equipment.

a. Daily preventive maintenance checks and services (par. 34.2).

b. Weekly preventive maintenance checks and services (par. 34.3).

c. Cleaning (par. 34.4).

d. Visual inspection (par. 35).

e. Use of the operational checklist (par. 36).

f. Replacement of the specified electron tubes (par. 37), the vibrating type voltage regulator, the pilot lamp on the main unit, and the fuse in the main unit, also the external transformer.

34. Preventive Maintenance

Preventive maintenance is the systematic care, servicing, and inspection of equipment to prevent the occurrence of trouble, to reduce downtime, and to assure that the equipment is serviceable.

a. Systematic Care. The procedures given in paragraphs 34.2 through 34.4 cover routine systematic care and cleaning essential to proper upkeep and operation of the equipment.

b. Preventive Maintenance Checks and Services. The preventive maintenance checks and services charts (pars. 34.2 and 34.3) outline functions to be performed at specific intervals. These checks and

services are to maintain Army electronic equipment in a combat serviceable condition; that is, in good general (physical) condition and in good operating condition. To assist operations in maintaining combat serviceability, the charts indicate what to check, how to check, and what the normal conditions are; the references column lists the illustrations, paragraphs, or manuals that contain detailed repair or replacement procedures. If the defect cannot be remedied by the operator, higher echelon maintenance or repair is required. Records and reports of these checks and services must be made in accordance with the requirements set forth in TM 33-750.

Page 57. Add paragraphs 34.1 through 34.4 after paragraph 34:

34.1 Preventive Maintenance Checks and Services Periods

Preventive maintenance checks and services of Radio Interference Measuring Set AN/URM-85 are required daily and weekly. Paragraphs 34.2 and 34.3 specifies the items to be checked and serviced. In addition to the routine daily checks and services, the equipment should be rechecked and serviced immediately before going on a mission and as soon after completion of the mission as possible.

34.2 Daily Preventive Maintenance Checks and Services Chart

| Sequence No. | Item | Procedure | References |
|--------------|--------------------------------|--|------------|
| 1 | Completeness | Check the equipment for completeness and general condition. | Appx III. |
| 2 | Exterior surfaces | Clean exterior surfaces of the equipment | Par. 34.4. |
| 3 | Knobs, controls, and switches. | During operation (item 6) check knobs, controls, and switches for proper mechanical and electrical action. Action should be positive without backlash, binding, or scraping. | Par. 36. |
| 4 | Meters | During operation (item 6), check meters for broken glass, and erratic pointer movement. | Par. 36. |
| 5 | Pilot lamps | During operation (item 6), check for burned-out pilot lamps. | Par. 36. |
| 6 | Operation | Perform the operational check and note all indications (par. 36). | Par. 36. |

34.3 Weekly Preventive Maintenance Checks and Services Chart

| Sequence No. | Item | Procedure | References |
|--------------|------------------------------|--|------------|
| 1 | Cords and cables | Inspect cords and cables for cuts, cracks, fraying, and broken terminations. | None. |
| 2 | Hardware | Inspect all exterior hardware for looseness and damage. | None. |
| 3 | Tripod storage bag | Inspect the tripod storage bag for fungus, fraying, tears, and broken zippers. | None. |
| 4 | Preservation | Inspect exterior metal surfaces for bare spots, rust, and corrosion. Refer to higher echelon maintenance for repair. | None. |

34.4 Cleaning

Inspect the exterior of Radio interference Measuring Set AN/URM-85. The exterior surfaces should be clean, and free of dust, dirt, grease, and fungus.

a. Remove dust and loose dirt with a clean soft cloth.

Warning: Cleaning Compound (Federal stock No. 7930-395-9542) is flammable and its

fumes are toxic. Provide adequate ventilation. Do not use near a flame.

b. Remove grease, fungus, and ground-in dirt from the cases; use a cloth dampened (not wet) with cleaning compound.

c. Remove dust or dirt from plugs and jacks with a brush.

Caution: Do not press on the meter faces (glass) when cleaning; the meter may become damaged.

d. Clean the front panels, meters, and control knobs; use a soft clean cloth. If dirt is difficult to remove, dampen the cloth with water; if necessary, use mild soap.

Page 58. Delete figure 26.

Page 59. Delete figure 27.

Page 68, paragraph 38b(1). Delete subparagraph (1) and substitute:

- (1) Monthly preventive maintenance checks and services (par. 40.2).

Add paragraph (1.1) after paragraph (1).

- (1.1.) Touchup painting instructions (par. 40.3).

Delete paragraph 40 and substitute:

40. Organizational Preventive Maintenance

a. Preventive maintenance is the systematic care, inspection, and servicing of equipment to maintain it in serviceable condition, prevent breakdowns, and assure maximum operation capability. Preventive maintenance is the responsibility of all echelons concerned with the equipment and includes the inspection, testing, and repair or replacement of parts, subassemblies, or units that inspections and tests indicate would probably fail before the next sched-

uled periodic service. Preventive maintenance checks and services of Radio Interference Measuring Set AN/URM-85 at the second echelon level are made at monthly intervals unless otherwise directed by the commanding officer.

b. Maintenance forms and records to be used and maintained on this equipment are specified in TM 38-750.

Add paragraphs 40.1 through 40.3.

40.1 Monthly Maintenance

Perform the maintenance functions indicated in the monthly preventive maintenance checks and services chart (par. 40.2) once each month. A month is defined as approximately 30 calendar days of 8-hour-per-day operation. If the equipment is operated 16 hours a day, the monthly preventive maintenance checks and services should be performed at 15-day intervals. Adjustment of the maintenance interval must be made to compensate for any unusual operating conditions. Equipment maintained in a standby (ready for immediate operation) condition must have monthly preventive maintenance checks and services. Equipment in limited storage (requires service before operation) does not require monthly preventive maintenance.

40.2 Monthly Preventive Maintenance Checks and Services chart

| Sequence No. | Item | Procedure | References |
|--------------|--------------------------------|---|----------------------------------|
| 1 | Publications | Inspect manual for completeness and to see that it is in usable condition. Be sure that all changes to the manual are on hand. | DA Pam 310-4. |
| 2 | Modification Work Orders. | Check to see that all URGENT MWO's have been applied and that all NORMAL MWO's have been scheduled. | DA Pam 310-4. |
| 3 | Completeness and Spare Parts. | Check the equipment for completeness and general condition. Check all spare parts (operator and organizational) for general condition and method of storage. There should be no evidence of overstock, and all shortages must be on valid requisitions. | Appx III and TM 11-6625-351-20P. |
| 4 | Preservation | Inspect exterior metal surfaces for bare spots, rust, and corrosion. | Par. 40.3. |
| 5 | Knobs, controls, and switches. | During operation (item 17), check knobs, controls, and switches for proper mechanical and electrical action. Action should be positive without backlash, binding, or scraping. | Par. 43. |
| 6 | Meters | During operation (item 17), check meters for broken glass and erratic pointer movements. | Par. 43. |
| 7 | Pilot lamps | During operation (item 17), check for burned-out pilot lamps. | Par. 43. |
| 8 | Cords and cables | Inspect cords and cables for cuts, cracks, fraying, and broken terminals. | None. |
| 9 | Hardware | Inspect all hardware for looseness and damage..... | None. |
| 10 | Fuses | Check fuses in use for proper value (par. 13)..... | None. |

| Sequence No. | Item | Procedure | References |
|--------------|-----------------------------|---|------------|
| 11 | Cleanliness | Clean exterior surfaces of the equipment..... | Par. 34.4. |
| 12 | Tripod storage bag | Inspect the tripod storage bag for fungus, fraying, tears, and broken zippers. | None. |
| 13 | Antenas and mounts | Inspect the antenas and mounts for tightness and cleanliness. | None. |
| 14 | Resistors and capacitors .. | Inspect resistors and capacitors for cracks, blistering, and other detrimental defects. | None. |
| 15 | Jacks and connectors | Inspect jacks and connectors for snug fit and good contact. | None. |
| 16 | Variable capacitors | Inspect variable capacitors for dirt, corrosion, and deformed plates. | None. |
| 17 | Operation | Make the equipment performance check and note all indications (par. 43). | Par. 43. |

40.3 Touchup Painting Instructions

Clean rust and corrosion from metal surfaces by lightly sanding them with fine sandpaper. Brush two thin coats of paint on the bare metal to protect it from further corrosion. Refer to the applicable cleaning and refinishing practices specified in TM 9-213.

Page 70, paragraph 43b. Add the following note after subparagraph b.

Note. Items 1 through 17 appear on page" 69.

Page 77. Delete figure 29.

Page 78. Delete figure 30.

Page 81, appendix I. Add the following:

DA Pam 310-4 Index of Technical Manuals, Technical Bulletins, Supply Bulletins, Lubrication Orders, and Modification Work Orders.

TM 9-213 Painting Instructions for Field use.

TM 38-750 The Army Equipment Record System and Procedures.

Change "TB SIG 255" to: TB SIG 225.

By Order of the Secretary of the Army:

EARLE G. WHEELER,
General, United States Army,
Chief of Staff.

Official:

J. C. LAMBERT,
Major General, United States Army,
The Adjutant General.

Distribution:

Active Army:

DASA (6)
USASA (2)
CNGB (1)
CofEngrs (1)
TSG (1)
CSigO (7)
CofT (1)
CofSptS (1)
USA CD Agcy (1)
USCONARC (5)
USAMC (5)
ARADCOM (2)
ARADCOM Rgn (2)
OS Maj Comd (3)
OS Base Comd (2)
LOGCOMD (2)
USAECOM (5)
USAMICOM (4)
USASCC (4)
MDW (1)
Armies (2)
Corps (2)
USA Corps (3)
USATC AD (2)
USATC Engr (2)
USATC Inf (2)
USATC Armor (2)
USASTC (5)
Instl (2) except
 Ft Monmouth (65)
Svc Colleges (2)
Br Svc Sch (2) except
GENDEP (OS) (2)
Sig Dep (OS) (12)
Sig Sec, GENDEP (5)

Army Dep (2) except
 Ft Worth (8)
 Lexington (12)
 Sacramento (28)
 Tobyhanna (12)
USA Elct RD Actv, White Sands (13)
USA Elct RD Actv, Ft Huachuca (2)
USA Trans Tml Comd (1)
Army Tml (1)
POE (1)
USAOSA (1)
AMS (1)
WRAMC (1)
AFIP (1)
Army Pic Cen (2)
USA Mbl Spt Cen (1)
USA Elct Mat Agcy (12)
Chicago Proc Dist (1)
USARCARIB Sig Agcy (1)
Sig Fld Maint Shop (3)
Units org under fol TOE (2 cy ea UNO
 11-7
 11-16
 11-57
 11-98
 11-117
 11-155
 11-157
 11-500 (AA-AC) (4)
 11-557
 11-587
 11-592
 11-597
 33-56

NG: State AG (3); units-same as Active Army except allowance is one copy to each unit.

USAR: None.

For explanation of abbreviations used, see AR 320-50.

RADIO INTERFERENCE MEASURING SET AN/URM-85

| | | Paragraph | Page |
|-------------------|--|-----------|------|
| C H A P T E R 1 . | I N T R O D U C T I O N | | 5 |
| S e c t i o n I . | G e n e r a l | | 5 |
| | S c o p e | 1 | 5 |
| | F o r m s a n d r e c o r d s | 2 | 5 |
| | I I . D e s c r i p t i o n a n d d a t a | | 9 |
| | P u r p o s e a n d u s e | 3 | 9 |
| | T e c h n i c a l c h a r a c t e r i s t i c s | 4 | 10 |
| | T a b l e o f c o m p o n e n t s | 5 | 11 |
| | C o m m o n n a m e s | 6 | 13 |
| | D e s c r i p t i o n o f t e s t s e t | 7 | 13 |
| | M a j o r c o m p o n e n t s | 8 | 14 |
| | M i n o r c o m p o n e n t s f o r u s e w i t h t u n i n g u n i t 1 | 9 | 15 |
| | M i n o r c o m p o n e n t s f o r u s e w i t h t u n i n g u n i t s 2, 3, a n d 4 | 10 | 16 |
| | M i n o r c o m p o n e n t s f o r u s e w i t h a l l t u n i n g u n i t s | 11 | 17 |
| C H A P T E R 2 . | I N S T A L L A T I O N A N D O P E R A T I N G I N S T R U C T I O N S | | 21 |
| S e c t i o n I . | S e r v i c e u p o n r e c e i p t o f e q u i p m e n t | | 21 |
| | U n p a c k i n g | 12 | 21 |
| | C h e c k i n g u n p a c k e d e q u i p m e n t | 13 | 23 |
| | P l a c e m e n t o f e q u i p m e n t | 14 | 22 |
| | I n t e r c o n n e c t i o n s | 15 | 24 |
| | I I . O p e r a t o r ' s c o n t r o l s a n d i n d i c a t o r s | | 27 |
| | D a m a g e f r o m i m p r o p e r s e t t i n g s a n d i m p r o p e r m o u n t i n g o f a n t e n n a s | 16 | 27 |
| | O p e r a t i n g c o n t r o l s , i n d i c a t o r s , a n d j a c k s | 17 | 27 |
| | I I I . O p e r a t i n g i n s t r u c t i o n s | | 32 |
| | T y p e s o f o p e r a t i o n | 18 | 32 |
| | S t a r t i n g a n d c a l i b r a t i n g p r o c e d u r e s | 19 | 38 |
| | M e a s u r e m e n t o f n a r r o w - b a n d c o n d u c t e d s i g n a l s | 20 | 40 |
| | M e a s u r e m e n t o f b r o a d b a n d c o n d u c t e d s i g n a l s | 21 | 41 |
| | N a r r o w - b a n d , f a r - f i e l d m e a s u r e m e n t s | 22 | 44 |
| | B r o a d b a n d , f a r - f i e l d m e a s u r e m e n t s | 23 | 46 |
| | N a r r o w - b a n d , n e a r - f i e l d m e a s u r e m e n t s | 24 | 46 |
| | B r o a d b a n d , n e a r - f i e l d m e a s u r e m e n t s | 25 | 50 |
| | M e a s u r i n g m o r e t h a n o n e l e v e l o f b r o a d b a n d s i g n a l s a t o n e f r e q u e n c y | 26 | 51 |
| | S u b s t i t u t i o n m e t h o d o f m e a s u r e m e n t u s i n g a u r a l s l i d e b a c k t e c h n i q u e | 27 | 51 |
| | S u b s t i t u t i o n m e t h o d o f m e a s u r e m e n t u s i n g m e t e r e d s l i d e b a c k t e c h n i q u e | 28 | 52 |
| | L o c a l i z i n g s o u r c e o f n o i s e i n t e r f e r e n c e | 29 | 53 |
| | C a r r i e r f i e l d i n t e n s i t y m e a s u r e m e n t s o v e r f r e q u e n c y r a n g e o f t u n i n g u n i t 1 | 30 | 53 |
| | C a r r i e r f i e l d i n t e n s i t y m e a s u r e m e n t s o v e r f r e q u e n c y r a n g e o f t u n i n g u n i t s 2,3, a n d 4 | 31 | 54 |
| | S t o p p i n g p r o c e d u r e | 32 | 55 |
| C H A P T E R 3 . | M A I N T E N A N C E I N S T R U C T I O N S | | 56 |
| S e c t i o n I . | O p e r a t o r ' s m a i n t e n a n c e | | 56 |
| | S c o p e o f o p e r a t o r ' s m a i n t e n a n c e | 33 | 56 |
| | O p e r a t o r ' s p r e v e n t i v e m a i n t e n a n c e | 34 | 56 |
| | O p e r a t o r ' s v i s u a l i n s p e c t i o n | 35 | 57 |
| | O p e r a t i o n a l c h e c k l i s t | 36 | 60 |
| | T u b e r e p l a c e m e n t | 37 | 68 |

- II. Organizational maintenance
 - Scope of organizational maintenance 38 68
 - Tools and materials required. 39 68
 - Orgizational preventive maintenance 40 68
 - Lubrication 41 70
 - Organizational repairman~s visual inspection 42 70
 - Equipment performance checklist 43 70
- CHAPTER 4 . SHIPMENT AND LIMITED STORAGE AND DEMOLITION TO PREVENT ENEMY USE 79
 - Section I. Shipment and limited storage
 - Disassembly of equipment 44 79
 - Repackaging for shipment or limited storage 45 79
 - II. Demolition of materiel to prevent enemy use
 - Authority for demolition 46 80
 - Methods of destruction 47 80
- A PPENDIX I. REFERENCE 81
 - II. MAINTENANCE ALLOCATION 82
 - III. BASIC ISSUE ITEMS LIST.... 88
- GLOSSARY 94

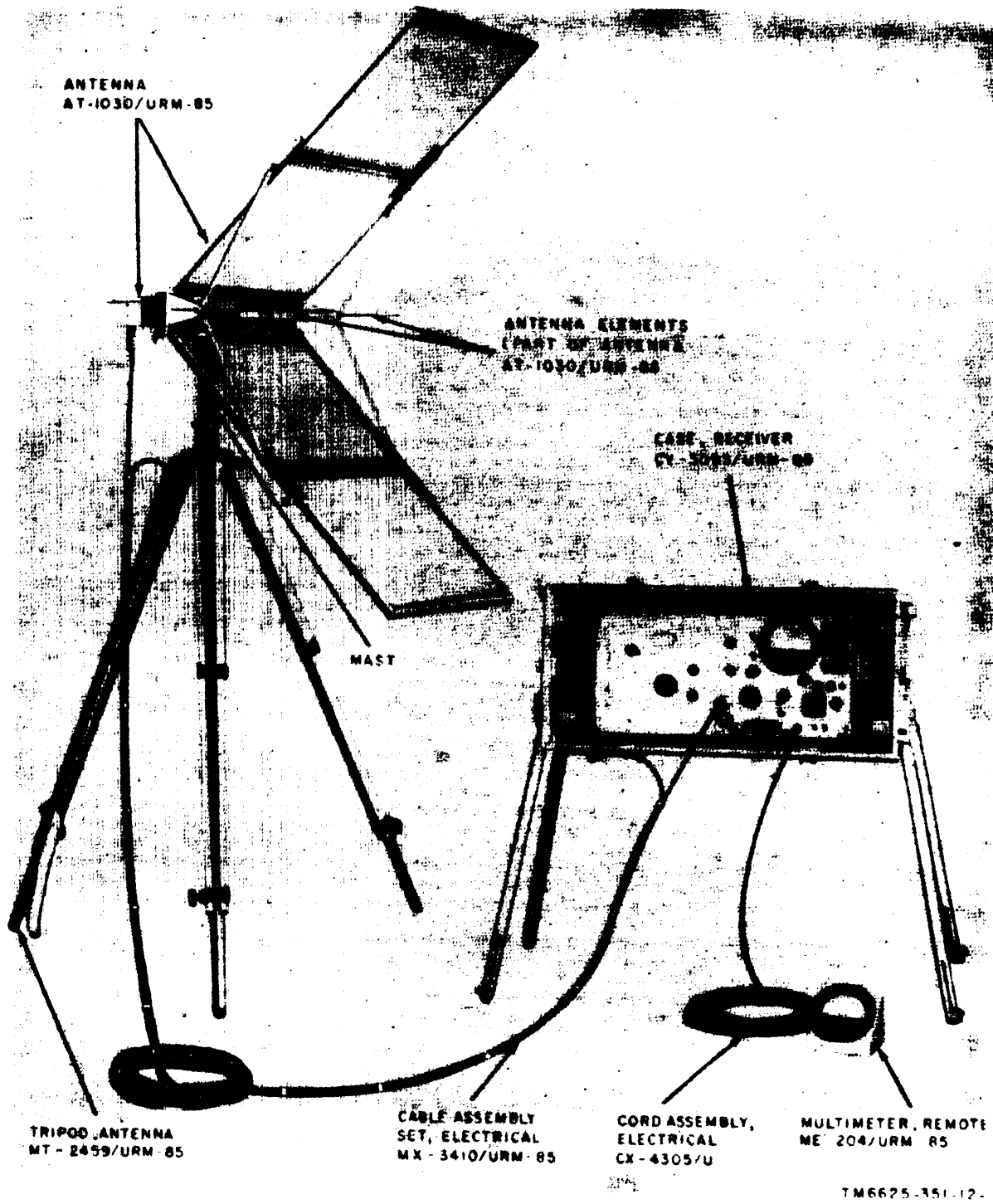

Figure 1. Radio Interference Measuring Set AN/URM-85, typical equipment setup.

CHAPTER 1

INTRODUCTION

Section I. GENERAL

1. Scope

This manual describes Radio Interference Measuring Set AN/URM-85 (fig. 1 through 6) and covers its installation, operation, and first and second echelon maintenance. It includes instructions for cleaning and inspection of the equipment, and replacement of parts available to first and second echelon maintenance personnel.

2. Forms and Records

a. Unsatisfactory Equipment Report. Fill out and forward DA Form 468 (Un-

satisfactory Equipment Report) direct to the Commanding Officer U.-S. Army Signal Materiel Support Agency, ATTN: SIGMS-ML, Fort Monmouth, N. J., as prescribed in AR 700-38.

b. Report of Damaged or Improper Shipment. Fill out and forward DD Form 6 (Report of Damaged or Improper Shipment), as prescribed in AR 700-58.

c. Preventive Maintenance Forms. Prepare DA Form 11-266 (fig. 26, 27, 29, and 30) (Maintenance Check List for Signal Equipment (Test Equipment)), in accordance with instructions on the form.

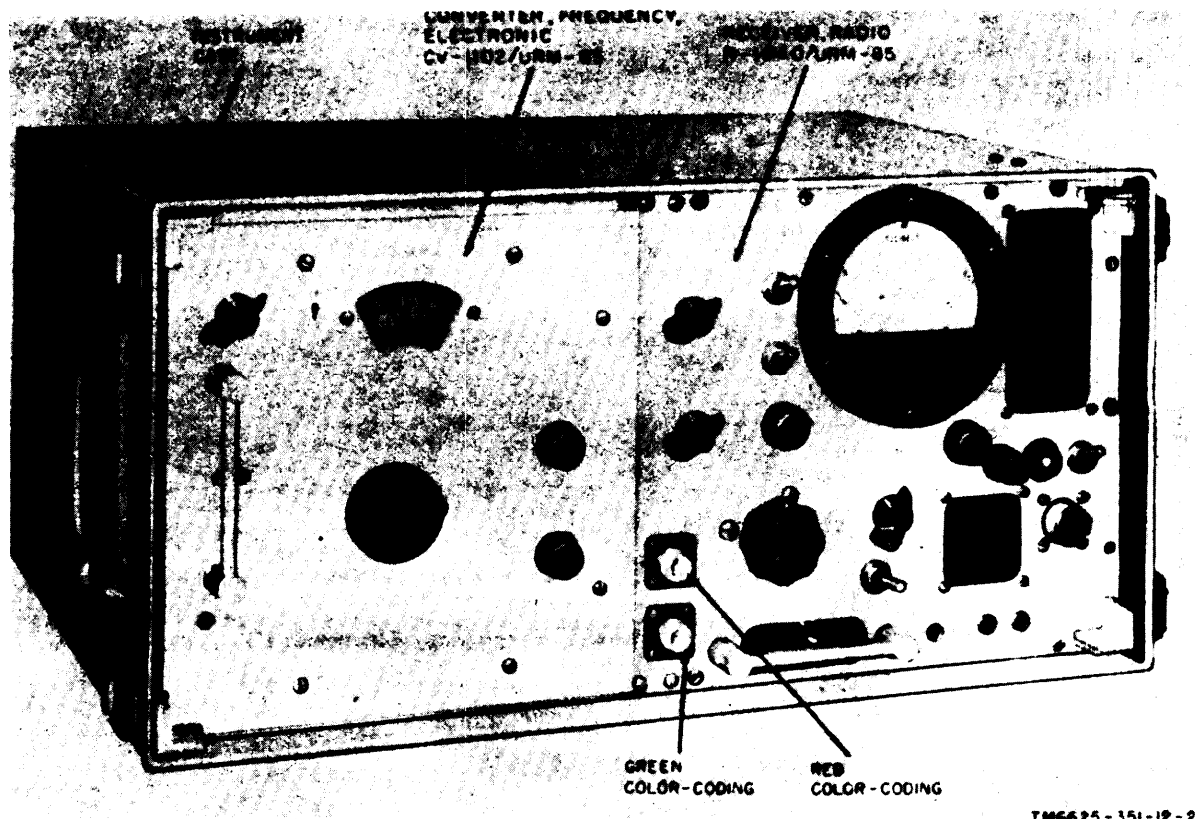

Figure 3. Receiver, Radio R-1040/URM-85, with Converter, Frequency, Electronic CV-1102/URM-85 in place.

d. *Parts List Form.* Forward DA Form 2028 (Recommended Changes to DA Technical Manual Parts Lists or Supply Manual 7, 8, or 9) direct to the Commanding Officer, U. S. Army Signal Materiel Support Agency, ATTN: SIGMS-ML, Fort Monmouth, N. J., with comments on parts list-

ings in appendixes II and III.

e. *Comments on Manual.* Forward all other comments on this manual direct to the Commanding Officer, U. S. Army Signal Materiel Support Agency, ATTN: SIGMS-PA2d, Fort Monmouth, N. J.

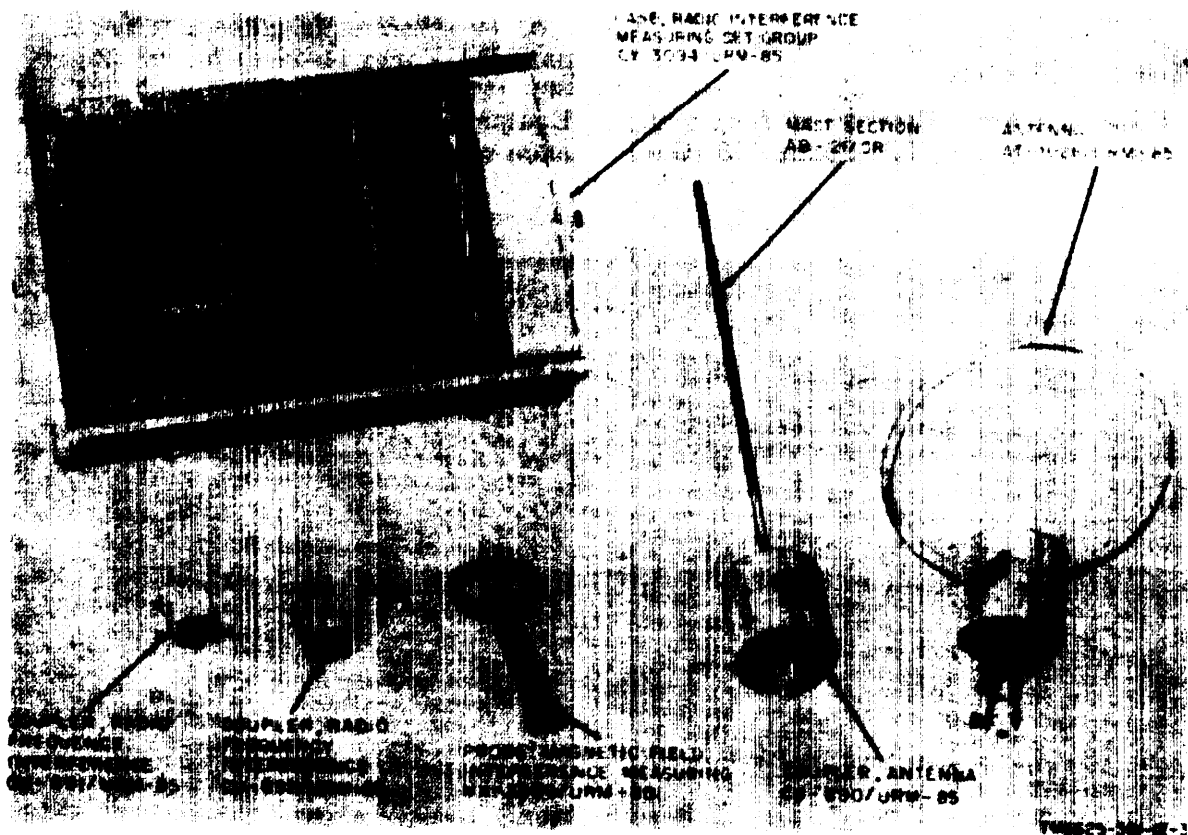

Figure 3. Minor components for use with Converter, Frequency, Electronic CV-1101/URM-86.

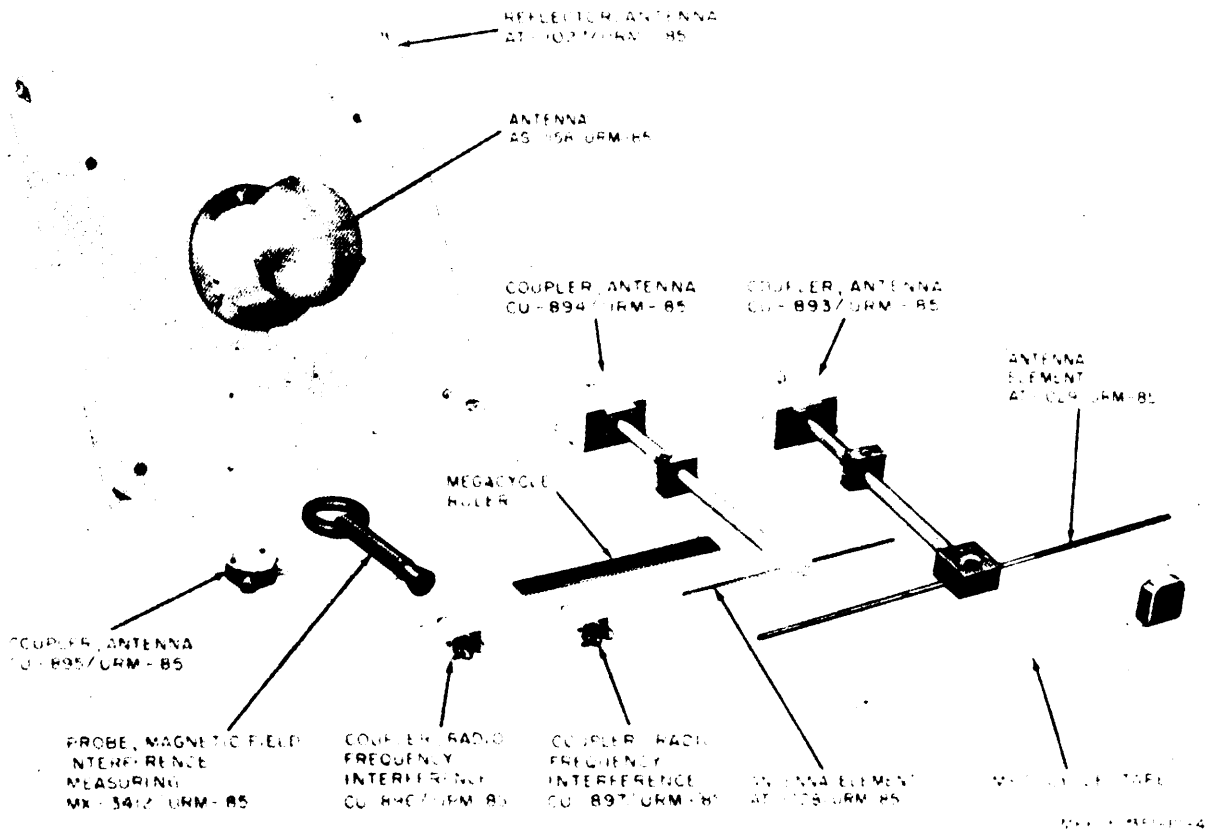

Figure 4. Minor components for we with Converters, Frequency, Electronic CV-1102/URM-86, CV-1103/URM-86, and CV-1104/URM-86.

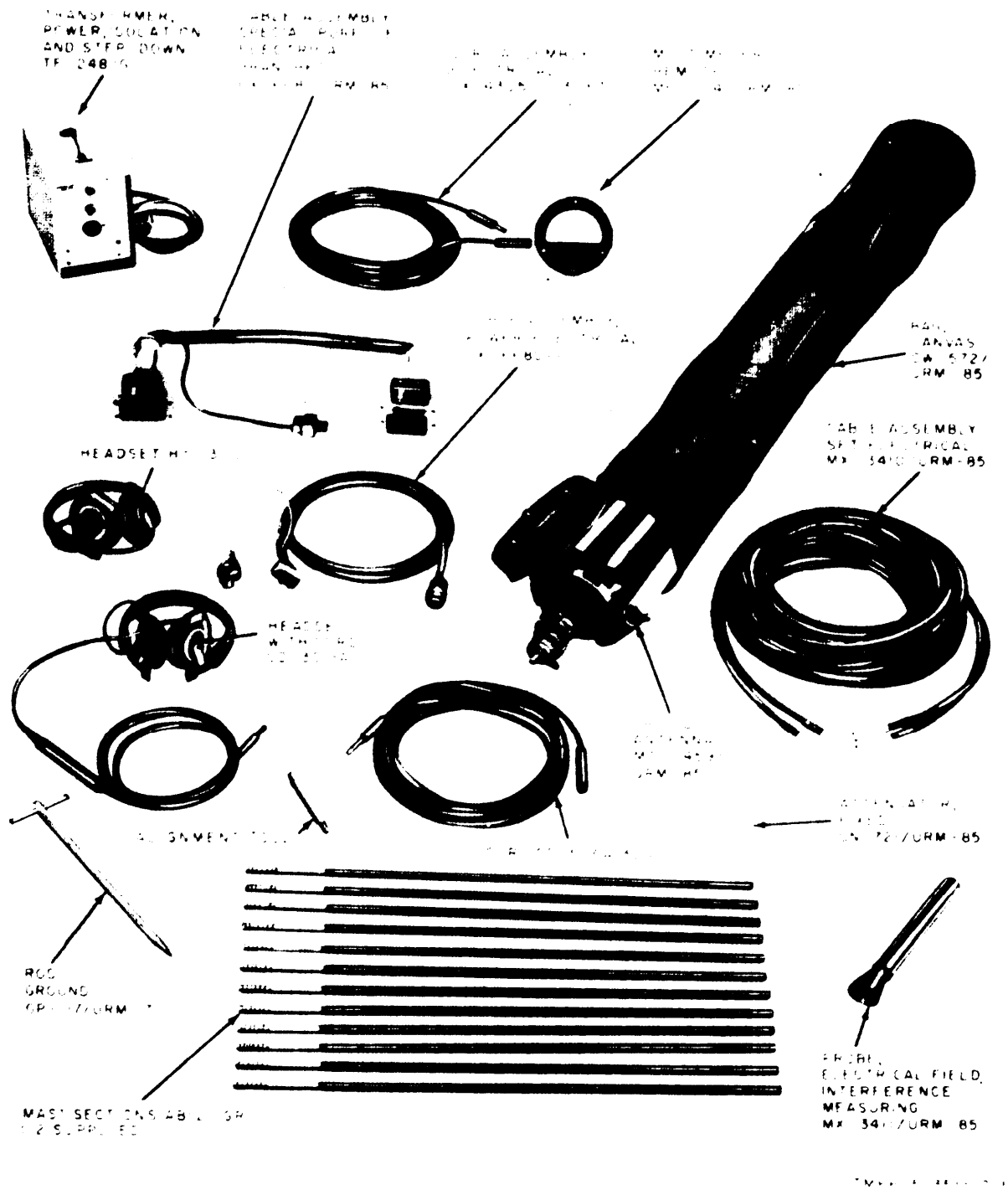

Figure 5. Minor components for use with Converters, Frequency, Electronic CV-1102/URM-85 through CV-1104/URM-85.

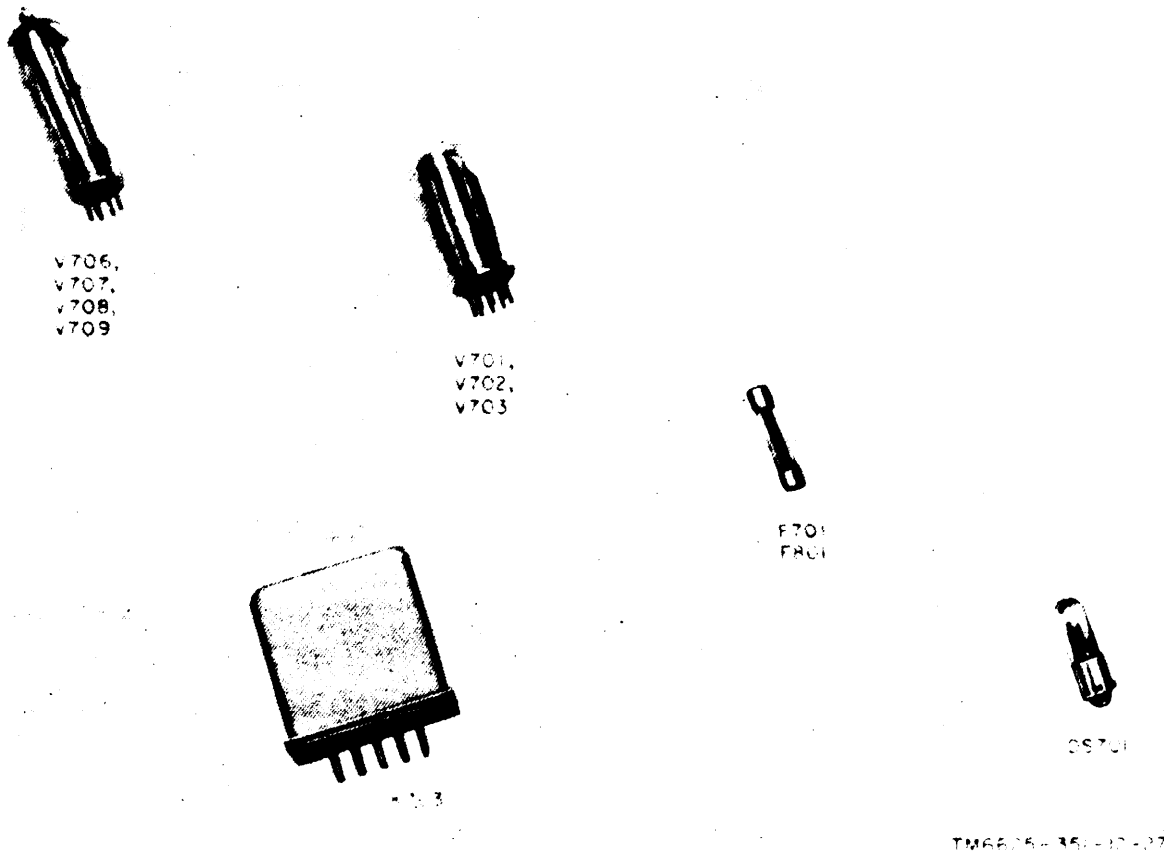

Figure 6. Converters, Frequency, Electronic CV-1101/URM-86, CV-1103/URM-86, and CV-1104/URM-85, with Case, Electronic Frequency Converter CY-3092/URM-85.

Section II. DESCRIPTION AND DATA

3. Purpose and Use

a. Radio Interference Measuring Set AN/URM-85 (fig. 1 through 6) is a portable test instrument which may be used both as a field intensity meter and as a radio interference (noise) meter. When the instrument is used as a field intensity meter, it measures the carrier field intensities of narrow band amplitude modulated (am.), frequency-modulated (fm), and unmodulated continuous-wave (cw) signals. These measurements are read in terms of microvolt and decibels (db) relative to 1 microvolt (rev). When the instrument is used as a noise meter, it measures the spectral intensity of broadband impulse interfer-

ence which originates in electrical and/or electronic equipment. Noise measurements are read in terms of microvolt per megacycle bandwidth and db relative to 1-microvolt-per-megacycle bandwidth. Noise field intensities are taken in terms of microvolt-per-megacycle bandwidth per meter.

b. The AN/URM-85 consists of a superheterodyne receiver housed in a metal instrument case, which has provisions for plugging in either Converter, Frequency, Electronic CV-1101/URM-85, CV-1102/URM-85, CV-1103/URM-85, or CV-1104/URM-85 (fig. 2 and 6). Six antenna assemblies (fig. 1, 3, and 4) are supplied for

covering discrete portions of the frequency spectrum from 150 kilocycles (kc) to 1,000 megacycles (mc), together with various accessory coupling devices, probes, cable assemblies, electrical cords, headsets, and a remote indicator. Components setup for operating from 400 to 1,000 mc are shown in figure 1.

c. The equipment is intended for both field and laboratory use and can be used for the following purposes:

- (1) Quantitative engineering evaluation of electronic systems interference.
- (2) Determining the probable utility of a site for reception of radio signals.
- (3) Determining the area of useful transmitter coverage.
- (4) Determining the effectiveness of rf interference suppression measures used on piston-drive engines, electrical generators, and other electrical machinery.
- (5) Measuring absolute field strength of transmitter signals.
- (6) Measuring the amplitude of radio-frequency (rf) interference voltage present across electrical power distribution lines.
- (7) Measuring spurious radiation.
- (8) Studying fading of radio signals, by recording signal strength as a plot versus time.
- (9) Studying round-the-clock-communication possibilities at a given site, by recording atmospherics versus time.
- (10) Monitoring noise radiation from repaired electronic equipment in depot maintenance, and in production-line quality control.

4. Technical Characteristics

a. Converter, Frequency, Electronic CV-1101/URM-85.

| | |
|--|-------------------|
| Frequency range: | |
| Band 1 | 150 to 360 kc. |
| Band 2 | 360 to 870 kc. |
| Band 3 | 870 kc to 2.1 mc. |
| Band 4 | 2.1 to 5.2 mc. |
| Band 5 | 5.2 to 12.7 mc. |
| Band 6 | 12.7 to 30.0 mc. |
| If. amplifier center frequency: | |
| Bands 1 and 3 | 455 kc. |
| Bands 2, 4, 5 and 6 | 1,600 kc. |

| | |
|---------------------------------|-----------------------------|
| Bandwidths: | |
| Band 1 | 7 kc ± 2 . |
| Band 2 | 11 kc ± 2 . |
| Band 3 | 11 kc ± 2 . |
| Band 4 | 11 kc ± 2 . |
| Band 5 | 15 kc ± 2 . |
| Band 6 | 15 kc ± 2 . |
| Cw sensitivity | 0.5 microvolt. |
| Impulse sensitivity | 54 db above 1 microvolt/mc. |
| Image rejection | 40 db. |
| If. rejection: | |
| Band 1 | 50 db. |
| Bands 2 through 6 | 60 db. |
| Dial calibration accuracy | ± 2 percent. |

b. Converter, Frequency, Electronic CV-1102/URM-85.

| | |
|--------------------------------------|-----------------------------|
| Frequency range: | |
| Band 1 | 20 to 70 mc. |
| Band 2 | 70 to 220 mc. |
| If. amplifier center frequency | 10.7 mc. |
| Bandwidth, for both bands | 80 kc ± 10 . |
| Cw sensitivity: | |
| Below 100 mc. | 1 microvolt. |
| Above 100 mc. | 1.5 microvolt. |
| Impulse sensitivity: | |
| Band 1 (20 to 70 mc) | 45 db above 1 microvolt/mc. |
| Band 2 (70 to 220 mc) | 48 db above 1 microvolt/mc. |
| Image rejection: | |
| Band 1 | 70 db. |
| Band 2 | 35 db. |
| If. rejection: | |
| 20 to 39.9 mc | 55 db. |
| 40 to 220 mc | 70 db. |
| Dial calibration accuracy | ± 2 percent. |

c. Converter, Frequency, Electronic CV-1103/URM-85.

| | |
|---|-----------------------------|
| Frequency range | 200 to 400 mc, in one band. |
| If. preamplifier center frequency | 42 mc. |
| If. amplifier center frequency | 42 mc. |
| Bandwidth | 400 kc ± 50 . |
| Cw sensitivity | 4 microvolts. |
| Impulse sensitivity | 45 db above 1 microvolt/mc. |
| Image rejection | 35 db. |
| If. rejection | 70 db. |
| Dial calibration accuracy | ± 2 percent. |

d. Converter, Frequency, Electronic CV-1104/URM-85.

| | |
|--|-----------------------------|
| Frequency range: | |
| Band 1 | 400 to 700 mc. |
| Band 2 | 700 to 1,000 mc. |
| If. preamplifier center frequency for both bands | 42 mc. |
| If. amplifier center frequency for both bands | 42 mc. |
| Bandwidth for both bands | 450 kc ± 40 . |
| Cw sensitivity | 5.5 microvolts. |
| Impulse sensitivity | 45 db above 1 microvolt/mc. |
| Image rejection: | |
| Band 1 | 40 db. |
| Band 2 | 35 db. |

If. rejection 70 db.
Dial calibration accuracy ±2 percent.
e. Receiver, Radio R-1040/URM-85
Receiver type Superheterodyne.
Types of signals received Am., fm, and unmodulated cw carrier signals. Broadband impulse signals.
Operating power requirements Nominal 110/125 or 220/250 volts, 50 to 60 cps, 100 volt-amperes; 120 or 240 volts, 50 to 400 cps when using Transformer, Power, Isolation and Step-Down TF-248/G.
Input impedance 50 ohms, in all positions of SIGNAL ATTENUATOR DB control except 0 SUBST. ONLY.
Voltage range as a two-terminal rf voltmeter:
For carrier intensity measurements (am., fm, and unmodulated cw) 1 to 100,000 microvolts, at an accuracy of ±20%.
For broadband impulse type (noise) intensity $\frac{1}{\text{BW}}$ microvolt/mc
 $\frac{100,000}{\text{BW}}$ microvolt/mc bandwidth, where BW represents the effective overall impulse noise bandwidth of the equipment, in mc.

Signal attenuator Coaxial type, producing 80 db total rf and if. attenuation, in 20-db steps.
Calibrating impulse noise source:
Pulse repetition rate 75 cps.
Pulse width Approximately 0.5 millimicrosecond, resulting in a useful spectrum which is flat from 150 kc to 1,000 mc.
Pulse amplitude Variable from 0 to 80 db above 1-microvolt/mc bandwidth.
Indicating meter 4-1/2-inch logarithmic movement, calibrated in microvolts (0.5 to 10) and decibels (-6 to +20) relative to 1-microvolt/mc bandwidth.

f. Transformer, Power, Isolation and Step-Down TF-248/G.

Input voltage 110/125 or 220/250 volts ac.
Input frequency 50 to 400 cps.
Output voltage and frequency 120 volts ac, 50 to 400 cps.

5. Table of Components

The components of Radio Interference Measuring Set AN/URM-85 are listed in a below and the running spares in b below.

a. Components (fig. 1-6).

| Quantity | Item | Height (in.) | Depth (in.) | Width (in.) | Unit weight (lb) |
|----------|---|--------------|-------------|-------------|------------------|
| 1 | Receiver, Radio R-1040/URM-85 | 10-3/16 | 15-3/4 | 21-3/8 | 53 |
| 1 | Converter, Frequency, Electronic CV-1101/URM-85 (150 kc to 30 mc) | 9 | 14-1/8 | 9-1/16 | 16.5 |
| 1 | Converter, Frequency, Electronic CV-1102/URM-85 (20 to 220 mc) | 9 | 14-1/8 | 9-1/16 | 15.5 |
| 1 | Converter, Frequency, Electronic CV-1103/URM-85 (200 to 400 mc) | 9 | 14-1/8 | 9-1/16 | 17 |
| 1 | Converter, Frequency, Electronic CV-1104/URM-85 (400 to 1,000 mc) | 9 | 14-1/8 | 9-1/16 | 19.5 |
| 1 | Antenna AS-1158/URM-85 (20 to 1,000 mc) | 9-1/2 | 8-1/4 | 8-1/4 | 2.6 |
| 1 | Antenna AT-1026/URM-85 (150 kc to 30 mc) | 15 | 5 | 13 | 3.8 |
| 1 | Antenna AT-1030/URM-85 (400 to 1,000 mc) | 22-5/8 | 4-3/8 | 21 | 6.5 |
| 1 | Coupler, Antenna CU-890/URM-85 (150 kc to 30 mc) | 8-1/2 | 5 | 5 | 2.7 |
| 1 | Coupler, Antenna CU-893/URM-85 (20 to 220 mc) | 2-3/4 | 3-1/8 | 24-1/8 | 1.8 |

| Quantity | Item | Height (in.) | Depth (in.) | Width (in.) | Unit weight (lb) |
|----------|--|---|-------------|-------------|------------------|
| 1 | Coupler, Antenna CU-894/URM-85 (200 to 400 mc) | 2-3/4 | 3-1/8 | 24-1/8 | 1.7 |
| 1 | Coupler, Antenna CU-895/URM-85 (20 to 1,000 mc) | 3-3/4 | 1-1/4 | 3-1/4 | .5 |
| 1 pair | Antenna Element AT-1028/URM-85 (200 to 400 mc) | 6-1/2 (collapsed); 15-1/2 (extended) | 3/8 | 3/8 | 0.06 |
| 1 pair | Antenna Element AT-1029/URM-85 (20 to 220 mc) | 12-1/4 (collapsed); 36 (extended) | 1/2 | 1/2 | 0.3 |
| 1 | Reflector, Antenna AT-1027/URM-85 (150 kc to 30 mc) | 24 | 1-1/4 | 24 | 6.5 |
| 1 | Tripod, Antenna MT-2459/URM-85 | 36 | 5-1/2 | 5-1/2 | 13 |
| 1 | Cord CD-307-A (30' 0") | 360 (lg) | | | 1 |
| 1 | Cord CD-307-A (5' 5") | 65 (lg) | | | 0.5 |
| 1 | Bag, Canvas CW-572/URM-85 | 45 | 7 | 7 | 4.4 |
| 1 | Cable Assembly Set, Electrical MX-3410/URM-85 | 360 (lg) | | | 5.4 |
| 1 | Cord Assembly, Electrical CX-4305/U | 360 (lg) | | | 1 |
| 1 | Probe, Electrical Field, Interference Measuring MX-3411/URM-85 (150 kc to 1,000 mc) | 8 | 7/8 | 7/8 | .4 |
| 1 | Cable Assembly, Power, Electrical CX-6680/U | 72 (lg) | | | 0.75 |
| 1 | Cable Assembly, Special Purpose, Electrical Branched CX-6681/URM-85 | 30 (lg) | 1 | 1 | 1.5 |
| 3 | Case, Electronic Frequency Converter CY-3092/URM-85 | 16-7/8 | 12-1/4 | 12-1/4 | 21.5 |
| 1 | Attenuator, Fixed CN-721/URM-85 (150 kc to 1,000 mc) | 3-5/8 | 3/4 | 3/4 | 0.3 |
| 1 | Rod, Ground GP-117/URM-7 | 1 | 1/2 | 3 | 0.4 |
| 2 | Headset H-113/U | 6 | | 4 | 0.6 |
| 1 | Probe, Magnetic Field, Interference Measuring MX-3409/URM-85 (150 kc to 30 mc) | 9 | | 3-3/8 | 1 |
| 1 | Probe, Magnetic Field, Interference Measuring MX-3412/URM-85 (20 to 1,000 mc) | 9 | | 3-3/8 | 1 |
| 12 | Mast Section AB-21/GR | 24 (lg) | 1/2 | 1/2 | 0.2 |
| 1 | Transformer, Power, Isolation and Step-Down TF-248/G | 6-7/16 | 7-5/8 | 4-5/8 | 10 |
| 1 | Coupler, Radio Frequency Interference CU-891/URM-85 (50 ohms; 150 kc to 30 mc) | 4 | 1-1/4 | 1-3/4 | 0.3 |
| 1 | Coupler, Radio Frequency Interference CU-892/URM-85 (500 ohms; 150 kc to 30 mc) | 4 | 1-1/4 | 1-3/4 | 0.3 |
| 1 | Coupler, Radio Frequency Interference CU-896/URM-85 (50 ohms; 20 to 1,000 mc) | 3-1/4 | 1-1/4 | 1-3/4 | 0.3 |
| 1 | Coupler, Radio Frequency Interference CU-897/URM-85 (500 ohms; 20 to 1,000 mc) | 3-1/4 | 1-1/4 | 1-3/4 | 0.3 |
| 1 | Case, Radio Interference Measuring Set Group CY-3094/URM-85 (for minor components cover- ing frequency range from 150 kc to 30 mc) | 8-1/8 | 15-1/4 | 23-7/8 | 24 |
| 1 | Case, Radio Interference Measuring Set Group CY-3095/URM-85 (for minor components cover- ing frequency range from 20 to 1,000 mc) | 16-7/8 | 26-5/8 | 26-5/8 | 69 |
| 1 | Case, Receiver CY-3093/URM-85 | 20-3/8 | 13-1/2 | 27-1/2 | 50.5 |
| 1 | Multimeter, Remote ME-204/URM-85 | 4-1/2 | 4-1/2 | 4-5/8 | 1.7 |
| 4 | Receiver case legs | 25 | 1-1/2 | 1 | 1.2 |
| 1 | Megacycle tape | 2 | 5/8 | 2 | 0.5 |
| 1 | Allen wrench (3/64") | | | | |
| 1 | Allen wrench (1/16") | | | | |
| 1 | Allen wrench (5/64") | | | | |
| 1 | Allen wrench (3/32") | | | | |
| 1 | Alignment tool | 4-3/8 | 3/8 | 3/8 | 0.1 |
| 1 | Calibration book | 1/2 | 7-1/4 | 5-1/2 | 0.5 |

| Quantity | Item | Height (in.) | Depth (in.) | Width (in.) | Unit weight (lb) |
|----------|--|--------------|-------------|-------------|------------------|
| 1 | Plastic megacycle ruler (400 to 1,000 mc) Technical manuals Running spares (b below) | 12 | 1/8 | 1-3/8 | 0.1 |
| 2 | | 1/4 | 10-1/2 | 8 | 0.3 |

b. Running Spares.

| Quantity | Item | Reference symbol |
|----------|--|------------------|
| 1 | Electron tube, OA2WA | V709 |
| 1 | Electron tube, OB2WA | V708 |
| 1 | Electron tube, 12AU7 | V703 |
| 1 | Electron tube, 5814A | V702 |
| 5 | Fuses, 2 ampere, slo blo, type F02D2R00B | F701, F801 |
| 5 | Lamps LM-52 | DS701 |
| 1 | Vibrating type voltage regulator | K703 |

| Nomenclature | Common name |
|---|---|
| Cord CD-307-A(5' 5" and 30' 0") | Short and long headset cords |
| Cable Assembly Set, Electrical MX-3410/URM-85 | Rf cable |
| Cord Assembly, Electrical CX-4305/U | Remote meter cord |
| Probe, Electrical Field, Interference Measuring MX-3411/URM-85 | Electric field probe |
| Cable Assembly, Power, Electrical, CX-6680/U | Ac power cable |
| Cable Assembly, Special Purpose, Electrical Branched CX-6681/URM-85 | Test harness |
| Probe, Magnetic Field, Interference Measuring MX-3409/URM-85 | Magnetic field probe for tuning unit 1 |
| Probe, Magnetic Field, Interference Measuring MX-3412/URM-85 | Magnetic field probe for tuning units 2, 3, and 4 |
| Transformer, Power, Isolation and Step-Down TF-248/G | External transformer |
| Coupler, Radio Frequency Interference CU-891/URM-85 | 50-ohm conductive coupler for tuning unit 1 |
| Coupler, Radio Frequency Interference CU-892/URM-85 | 500-ohm conductive coupler for tuning unit 1 |
| Coupler, Radio Frequency Interference CU-896/URM-85 | 50-ohm conductive coupler for tuning units 2, 3, and 4 |
| Coupler, Radio Frequency Interference CU-897/URM-85 | 500-ohm conductive coupler for tuning units 2, 3, and 4 |
| Case, Receiver CY-3093/URM-85 | Transit chest |
| Multimeter, Remote ME-204/URM-85 | Remote meter |
| Case, Electronic Frequency Converter CY-3902/URM-85 (3 each) | Transit case |
| Rod, Ground GP-117/URM-7 | Ground rod |

6. Common Names

| Nomenclature | Common name |
|---|--|
| Radio Interference Measuring Set AN/URM-85 | Test set |
| Receiver, Radio R-1040/URM-85 | Main unit |
| Converter, Frequency, Electronic CV-1101/URM-85 | Tuning unit 1 |
| Converter, Frequency, Electronic CV-1102/URM-85 | Tuning unit 2 |
| Converter, Frequency, Electronic CV-1103/URM-85 | Tuning unit 3 |
| Converter, Frequency, Electronic CV-1104/URM-85 | Tuning unit 4 |
| Antenna AS-1158/URM-85 | Discone (broadband) antenna |
| Antenna AT-1026/URM-85 | Loop antenna |
| Antenna AT-1030/URM-85 | Dipole antenna and reflector for tuning unit 4 |
| Coupler, Antenna CU-890/URM-85 and Mast Sections AB-21/GR | Vertical antenna |
| Coupler, Antenna CU-890/URM-85 | Vertical antenna base |
| Coupler, Antenna CU-893/URM-85 | Balun for tuning unit 2 |
| Coupler, Antenna CU-894/URM-85 | Balun for tuning unit 3 |
| Coupler, Antenna CU-895/URM-85 | Unbalanced injection block |
| Reflector, Antenna AT-1027/URM-85 | Ground plane |
| Tripod, Antenna MT-2459/URM-85 | Tripod |
| Bag, Canvas CW-572/URM-85 | Tripod storage bag |

7. Description of Test Set

a. Basically, the test set is a field intensity meter that consists of a signal pickup device, a superheterodyne receiver, an impulse (noise) calibrator, and an

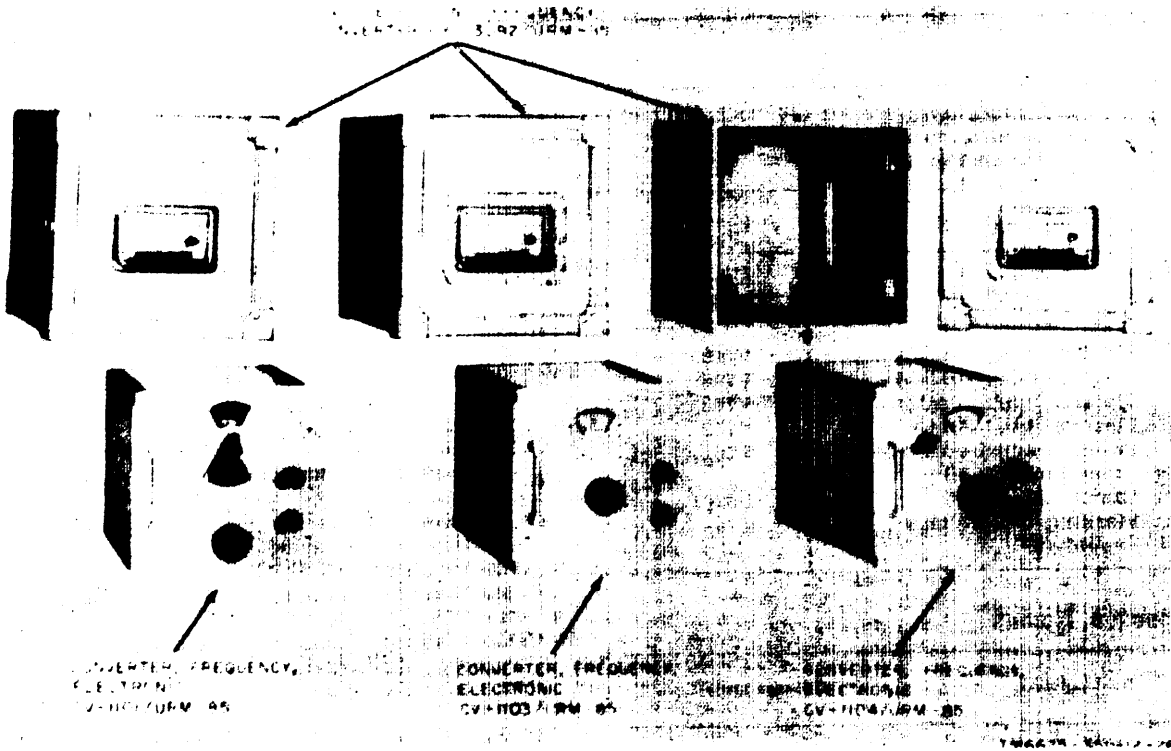

Figure 7. Running spares.

indicator. The pickup devices and remote indicator are listed in paragraph 5a and described in paragraphs 9 through 11. The front (rf) end and signal detector circuits of the superheterodyne receiver are housed in the plug-in tuning units. Each tuning unit covers a particular portion (para 4a through d) of the total range of the test set. The impulse calibrator and indicating circuits are housed in the main unit (para 8). Two types of indicating circuits are provided. One type consists of a vacuum-tube voltmeter which drives the panel-mounted meter and simultaneously produces an indication on the remote meter (when used). A second type of indicating circuit produces an aural signal which can be monitored through the headsets.

b. When desired, the output of the test set may be recorded as a plot of amplitude versus time on a 100-microampere recording meter that has an impedance of 1,500 ohms. The recording meter (not sup-

plied) may be used as a substitute device for the remote meter (ME-204/URM-85).

8. Major Components

a. *Receiver, Radio R-1040/URM-85* (fig. 2).

- (1) The R-1040/URM-85 is a panel-chassis assembly housed in an instrument case equipped with two carrying handles. A detachable, gasketed front cover (not shown) protects the operating controls and meter.
- (2) The front panel contains a meter, controls, and receptacles for operation of the equipment. An opening on the left side of the R-1040/URM-85 is for inserting one of the four plug-in tuning units supplied. A jack on the inside rear wall of the tuning compartment mates the plug at the rear of each tuning unit so

that operating power, rf signal power, audio signal power, and the dc metering signal are interconnected between the tuning unit and the R-1040/URM-85.

- (3) A tuning unit must be operated outside the R-1040/URM-85 during alignment and testing. A 30-inch long test harness (CX-6681/URM-85) (fig. 5) interconnects the tuning unit and the R-1040/URM-85. The male plug on one end of the test harness mates the jack on the inside rear wall of the tuning unit. The female plug on the other end of the test harness mates the connector at the rear of the tuning unit. A two-socket receptacle on the right wall of the tuning unit compartment is for plugging in the male two-prong plug on the third branch of the test harness.
- (4) Power is applied to the R-1040/URM-85 through the POWER receptacle at the lower right corner of the front panel. A detachable alternating current (ac) power cable (para 11k) connects the R-1040/URM-85 to the power source.
- (5) Color-coding is used on the two N-type rf receptacles located at the bottom center of the front panel. The SIGNAL INPUT receptacle is color-coded red to match the coding on one of the two plugs terminating the receiver end of the rf cable (MX-3410/URM-85). The IMPULSE OUTPUT receptacle is color-coded green to match the coding of the second plug terminating the receiver end of the same cable.

b. Converter, Frequency, Electronic CV-1101/URM-85, CV-1102/URM-85, CV-1103/URM-85, and CV-1104/URM-85.

- (1) The tuning units are panel-chassis assemblies. One of the four tuning units is normally transported plugged into the R-1040/URM-85 (fig. 2). Each of the three remaining tuning units is stored in its case CY-3092/URM-85 (fig. 6).
- (2) With a tuning unit plugged into the

main unit, all power and signal connections are made through a connector, on the rear of the tuning unit, which mates with a receptacle on the interior of the rear wall of the main unit. Cable Assembly, Special Purpose, Electrical Branched CX-6681/URM-85 (fig. 5) may be used to interconnect a tuning unit to the main unit for test and alignment purposes.

9. Minor Components for Use With Tuning Unit 1

(fig. 3)

a. One pickup device is the AT-1026/URM-85, which covers a frequency range from 150 kc to 30 mc in six bands. The desired band is selected by means of a band switch located on the loop base. Impedance matching networks and an injection network, which attenuates the output signal from the impulse generator, are housed inside the loop base. The green color-coded receptacle on the base of the antenna, receives the output from the impulse generator through the green color-coded mating plug of the MX-3410/URM-85 (fig. 10). The red color-coded receptacle, also on the base of the antenna, delivers the incoming rf or noise signal, through the mating red color-coded plug on the MX-3410/URM-85 to the R-1040/URM-85.

b. A second pickup device is a vertical antenna which also covers a frequency range from 150 kc to 30 mc, in six bands. This antenna consists of a base (Coupler, Antenna CU-890/URM-85) and five lengths of Mast Section AB-21/GR. Similar to the AT-1026/URM-85, the vertical antenna base houses matching transformers, an injection network for the impulse generator signal, and a band switch to select the desired operating band. The vertical antenna is always used with the ground plane (Reflector, Antenna AT-1027/URM-85) which, in turn, is attached to Tripod, Antenna MT-2459/URM-85. The green color-coded receptacle on the base of the antenna receives the output from the impulse generator through the green color-coded mating plug of the MX-3410/URM-85 (fig. 10).

The red color-coded receptacle, also on the base of the antenna, delivers the incoming rf or noise signal, through the mating red color-coded plug on the rf cable (MX-3410/URM-85), to the main unit.

c. A third pickup device is Probe, Magnetic Field, Interference Measuring MX-3409/URM-85. This device is used to localize magnetic field components of rf interference. It consists of a cylindrical handle, with a loop on one end and an N-type connector on the other end. The entire assembly is insulated to safeguard operating personnel against shock-hazard.

d. A fourth pickup device, used for conductive coupling of signals, is Coupler, Radio Frequency Interference CU-891/URM-85. This device is housed in a rectangular metal container and equipped with two binding posts to facilitate connections to power-lines having a nominal 50-ohm impedance. One binding post, marked HI, is used for connecting to the high side of the powerline. The second binding post, marked GND, is used to connect to the grounded (or leg closest to ground potential) side of the powerline. An N-type connector, at the opposite end of the metal container, mates with the red color-coded plug on the rf cable (MX-3410/URM-85).

e. A fifth pickup device, also used for conductive coupling of signals, is Coupler, Radio Frequency Interference CU-892/URM-85. This device, also housed in a metal container, is equipped with two binding posts to facilitate connections to powerlines that have a nominal 500-ohm impedance. The three connectors on this device are connected as described in *d* above.

f. The accessories in *a* through *e* above are stored and transported in Case, Radio Interference Measuring Set Group CY-3094/URM-85. A handle is provided for carrying the case. An air release valve is provided to equalize air pressure before opening the cover. The hinged, removable cover (not shown) is secured to the case by four latches.

10. Minor Components for Use with Tuning Units 2, 3, and 4

(fig. 4)

a. One pickup device, utilizing the radiated method of-coupling to the signal being measured, is the AS-1158/URM-85. This antenna is used in the frequency range of 20 mc to 1,000 mc, and must be used with the AT-1027/URM-85. Three 1/4-turn fasteners, in the flange of the AS-1158/URM-85, permit this antenna to be secured to the AT-1027/URM-85. Two additional 1/4-turn fasteners, in the hinged bracket of the AT-1027/URM-85, secure the combined antenna and AT-1027/URM-85 assembly to the tripod. Three sockets, at the top surface of the AS-1158/URM-85, accept the required number of Mast Sections AB-21/GR (fig. 25) for resonating with the signal under measurement.

b. A second pickup device, utilizing the radiated method of coupling to the signal being measured, consists of the CU-893/URM-85 and its dipole antenna. The balun is a device for converting a balanced feeding system (the two dipole arms) into an unbalanced feed (the coaxial cable connected to the main unit input receptacle). When operating over the frequency range from 20 to 70 mc, each dipole arm consists of the required number of Mast Sections AB-21/GR (para 22d) and one adjustable Antenna Element AT-1029/URM-85. When operating over the frequency range from 70 to 220 mc, each dipole arm consists of only Antenna Element AT-1029/URM-85. Each Antenna Element AT-1029/URM-85 may be varied from its collapsed length of 12-1/4 inches to its fully extended length of 36 inches. An N-connector type on the balun connects the signal under measurement, through the red color-coded plug on the rf cable, to the input of the main unit. The complete assembly (balun and dipole antenna) mounts on the tripod.

c. A third pickup device, using the radiated method of coupling to the signal being measured, consists of the CU-894/URM-85 and its dipole antenna. This device functions essentially the same as the antenna for tuning unit 2, (CU-893/URM-85), (*b* above), except that the antenna end of

the balun is encased in a Plexiglass block. Two adjustable antenna sections (Antenna Element AT-1028/URM85) are provided for covering the frequency range. Each section is 15-1/2 inches long when fully extended, and 6-1/2 inches long when fully collapsed. The complete assembly (balun and dipole antenna) mounts on the tripod.

d. A fourth pickup device, also using the radiated method of coupling, is Antenna AT-1030/URM-85. This antenna is used with tuning unit 4, and combines the balun, adjustable dipole arms, and a corner reflector into one integral assembly (fig. 1). The dipole arms may be extended from their minimum collapsed length of 2-1/4 inches to their maximum length of approximately 6-1/2 inches. The spacing between the balun and the apex of the corner reflector is variable. The entire assembly is designed for mounting to the mast of the tripod.

e. Probe, Magnetic, Interference Measuring MX-3412/URM-85, which is a pickup device for magnetic coupling, is used with tuning units 2, 3, and 4 to localize magnetic field components of rf interference. It consists of a cylindrical handle with a loop on one end and an N-type connector on the other. The entire assembly is insulated to safeguard operating personnel against shock hazard.

f. The unbalanced injection block is used to couple the AS-1158/URM-85 to the two color-coded plugs on the rf cable. The unbalanced injection block is housed in a metal and plastic container. Two connectors are located, adjacent to each other, at one end of the block; a single connector is located at the opposite end of the block. To facilitate proper interunit cabling, one of the two adjacent connectors is color-coded red; the second connector is color-coded green. The connector at the other end of the block is not color-coded, since no distinction is required in mating this end of the unbalanced injection block to the N-type receptacle at the base of the AS-1158/URM-85.

g. Coupler, Radio Frequency Interference CU-896/URM-85 is a conductive

coupling network housed in a rectangular metal block. The input end has two binding posts; the output end has an N-type receptacle. This coupler is used for picking up rf interference on electrical powerlines and audio-signal lines having a nominal 50-ohm impedance.

h. Coupler, Radio Frequency Interference CU-897/URM-85 is also a coupling network housed in a metal block. Its construction is the same as the 50-ohm coupler (g above), except that this coupler is used for picking up rf interference on electrical powerlines and audio-signal lines having a nominal 500-ohm impedance.

i. A flexible megacycle tape, calibrated in megacycles, is used when adjusting the dipole arms on the antennas for tuning units 2 and 3 to the desired resonant frequency. Antenna length is measured from *the exact center* of the dipole to the extreme tip of one dipole arm. The procedure is repeated for the other dipole arm.

j. A separate megacycle ruler is provided for Antenna AT-1030/URM-85, the high-frequency antenna (400 to 1,000 mc). One side of the ruler is calibrated for measuring the length of the dipole arms in mc. The other side indicates the spacing in mc, required between the dipole and the corner of the reflector.

k. Case, Radio Interference Measuring Set Group CY-3095/URM-85 is a transit chest used to transport all accessories except those specifically provided for tuning unit 1. Two handles are provided for carrying the chest, and eight spring-loaded catches fasten the watertight cover. An air release valve is provided to equalize air pressure before opening the cover. Spare parts for the equipment are stored in a compartment in the cover of the chest. Some of the minor components are stored in an accessory tray (fig. 8) which is also stored in the transit chest.

11. Minor Components for Use With All Tuning Units

(fig. 5)

a. Mast Sections AB-21/GR are made of tubing with male threads at one end and female threads at the opposite end. The

mast sections are used with the discone (broadband) antenna, with the vertical antenna for tuning unit 1, and with the dipole antenna covering the low band (20 to 70 mc) of tuning unit 2.

b. The MT-2459/URM-85 is used to mount all antennas. The base section has three wooden legs which can be extended from 44-1/2 inches to 58-1/2 inches. Three telescoping cylindrical masts (fig. 1), mounted to the center of the MT-2459/URM-85, are used to raise the dipole antenna (except for AT-1030/URM-85) to a maximum height of approximately 14 feet. When operating with the other types of antennas, such as Antenna AT-1030/URM-85, or the loop, vertical, or discone (broadband) antenna, only the lowest mast is used. Bag, Canvas CW-572/URM-85 is provided for storing and carrying the MT-2459/URM-85. One end of the CW-572/URM-85 is secured by a zipper, which is opened when the MT-2459/URM-85 is removed or replaced.

c. The MX-3411/URM-85 is used with all four tuning units to localize electrical field components of rf interference. This unit is fully insulated to protect operating personnel against shock hazard.

d. The ME-204/URM-85 measures 4-5/8 by 4-1/4 by 4-1/4 inches and has a sloping face on which the meter is mounted. The meter scale and movement are identical with the meter mounted on the main unit front panel. A jack on one side of the case accepts the remote meter cord.

e. Cord Assembly, Electrical CX-4305/U is a 30-foot cable used to connect the main unit to the ME-204/URM-85. Each end of the cord is terminated in telephone plug PJ-068.

f. Headset H-113/U (two supplied) connects to one of the two PHONES jack on the main unit front panel. Three cables (g below) are provided for use with the headsets.

g. Three Cords CD-307-A are provided as headset extension cords. Two are 65 inches long and one is 30 feet long. One end of each is terminated in telephone jack JJ-026; the other end is terminated in telephone plug PJ-055B. The 30-foot cord is supplied for monitoring aural sig-

nals at 8. remote distance (up to 30 feet) from the main unit.

h. Attenuator, Fixed CN-721/URM-85 is a 40-db attenuator, housed in a coaxial structure with N-male type connector at one end and a N-female type connector at the opposite end. The CN-721/URM-85 is used when the main unit variable signal attenuator range is insufficient for large amplitude rf input signals. The fixed attenuator extends the range of the panel-mounted meter to 10 volts when it is inserted in series with the MX-3410/URM-85 and the SIGNAL INPUT connector.

i. Rod, Ground GP-117/URM-7 is 12 inches long, with a pointed end to facilitate insertion into earth ground. A 3-inch bar forms a T-section handle.

j. The MX-3410/URM-85 consists of two 30-foot cables that are taped together at fixed intervals to prevent shifting in their relative position. There are two N-type male connectors at each end. One connector has a green plastic band and connects to the IMPULSE OUTPUT receptacle on the main unit; the other connector has a red plastic band and connects to the SIGNAL INPUT receptacle on the main unit.

k. The CX-6680/U has three conductors and is used to connect the main unit to an ac power source. One end is terminated in an AN plug; the other end is terminated in a two-prong male plug and a battery clip (for grounding purposes).

l. The CX-6681/URM-85 is used to interconnect a plug-in tuning unit and the main unit. It is 30 inches long and has three connectors. One connector is a multipin male plug that mates with the multipin jack mounted on the main unit inside rear wall of the the tuning unit compartment. A second connector is a multipin female plug that mates with the connector at the rear of any one of the four tuning units. The third connector is a 2-prong male plug that mates with the receptacle on the right wall of the main unit tuning unit compartment.

- (1) Each of the two multipin connectors has a normally open microswitch on its housing. The plunger of each microswitch extends beyond the

connector housing. As the connector mates with its appropriate receptacle, the plunger is depressed and the microswitch contacts are set to their closed circuit position.

(2) A microswitch on the main unit opens the ac power circuit when a tuning unit is withdrawn from the tuning unit compartment. When the two micro switches on the CX-6681/URM-85 are closed, they bypass the open-circuited microswitch on the main unit and create a complete path for the ac input powerlines.

(3) With all three connectors of the CX-6681/URM-85 plugged into their mating receptacles, a tuning unit can be operated outside the main unit for alignment and testing procedures.

m. The CY-3093/URM-85 (fig. 1) is used to transport the instrument case, containing the R-1040/URM-85 and one tuning unit (fig. 2). Two handles are provided for carrying the case, and two spring-loaded catches on each side are used for fastening the watertight cover. Four rail-type shock mounts protect the tuning unit and main unit from shock and vibration. Four supporting legs and a calibration book are contained inside the transit chest cover (not shown). The legs fit into brackets at each

end of the transit chest. An air release valve is provided to equalize air pressure before opening the cover.

n. An alignment tool (fig. 5) is supplied for use on N-type receptacles and connectors. One end of the tool permits straightening of the connector male pin, and readjusts the separation between the pin and the connector shell. The other end of the tool permits realignment of the miniature female receptacle, and readjusts the separation between the receptacle and its shell.

o. Three Cases, Electronic Frequency Converter CY-3092/URM-85 (fig. 6) are used to transport and store each of the three tuning units not in use. One handle at the top is used to carry the case. Four spring-loaded catches fasten the watertight cover. Rail-type shock mounts protect the tuning unit from shock and vibration. An air release valve is provided to equalize air pressure before opening the cover.

p. The TF-248/G (fig. 5) is a panel-chassis assembly contained in a case equipped with a carrying handle. The front panel contains the switches and an ac power output receptacle. A fuse and an ac power cord are on the rear of the case.

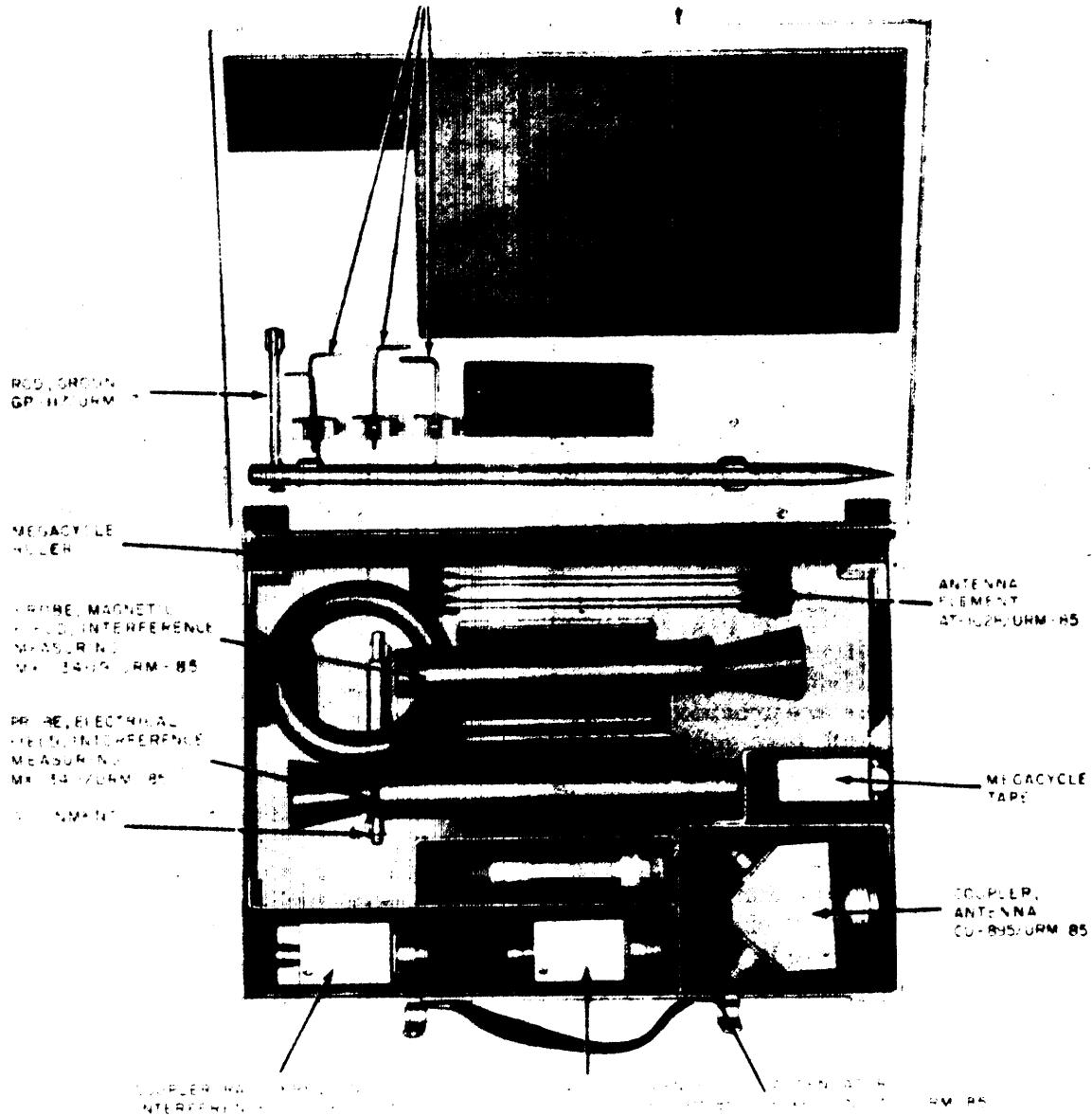

Figure 8. Accessory tray, minor components location diagram.

CHAPTER 2

INSTALLATION AND OPERATING INSTRUCTIONS

Section I. SERVICE UPON RECEIPT OF EQUIPMENT

12. Unpacking

a. Packaging Data. When packaged for shipment, the components of Radio Interference Measuring Set AN/URM-85 are

placed in cartons and packed in five wooden packing cases. A typical wooden packing case and its contents are shown in figure 9. The following chart lists the dimensions and contents of each wooden packing case.

| Case No. | Dimensions (in.) | Volume (cu ft) | Unit weight (lb) | Contents |
|-----------------------------------|----------------------|----------------|------------------|--|
| 1 of 5 | 38 x 14 x 19 | 5.8 | 140 | Converters, Frequency, Electronic CV-1102/URM-85, CV-1103/URM-85, and CV-1104/URM-85, each within Case, Electronic Frequency Converter CY-3092/URM-85. |
| 2 of 5 | 10 x 17 x 26 | 2.6 | 51 | Receiver, Radio R-1040/URM-85 and Converter, Frequency, Electronic CV-1101/URM-85 within Case, Receiver CY-3093/URM-85. |
| 3 of 5 | 29 x 19 x 33-1/2 | 10.6 | 148 | Case, Radio Interference Measuring Set Group CY-3095/URM-85, including Transformer, Power, Isolation and Step-Down TF-248/G and the minor components for covering the frequency range from 20 to 1,000 mc. |
| 4 of 5 | 16 x 22 x 31 | 6.3 | 128 | Case, Radio Interference Measuring Set Group CY-3094/URM-85, including the minor components for covering the frequency range from 150 kc to 30 mc. |
| 5 of 5 | 52 x 10-1/2 x 10-1/2 | 3.1 | 40 | Tripod, Antenna MT-2459/URM-85, within Bag, Canvas CW-572/URM-85. |
| Total Weight 507 | | | | |

b. Removing Contents. Equipment may be shipped in oversea or domestic packing cases. The wooden packing cases will be strapped for oversea shipment. When the equipment is received, select a location that is convenient to permanent or semi-permanent installation where the equipment may be unpacked without exposure to the elements.

Caution: Be careful when uncrating, unpacking, and handling the equipment; it is easily damaged. If it becomes damaged, a complete overhaul may be required or it may be made useless.

- (1) Cut and fold back the metal straps (when used).
- (2) Remove the nails from the top and one side of the wooden packing case with a nailpuller. Remove the top

and one side. Do not pry off the side and top; prying may damage the equipment.

- (3) Remove the corrugated filler and the technical manuals.
- (4) Open the waterproof barrier and remove the outer corrugated carton.
- (5) Open the outer corrugated carton and the moisture-vaporproof barrier and remove the inner corrugated carton.
- (6) Open the inner corrugated carton and remove the contents.

c. Location of Running Spares. The running spares (para 5h) are in the spare parts compartment provided on the lid of Case, Radio Interference Measuring Set Group CY-3095/URM-85.

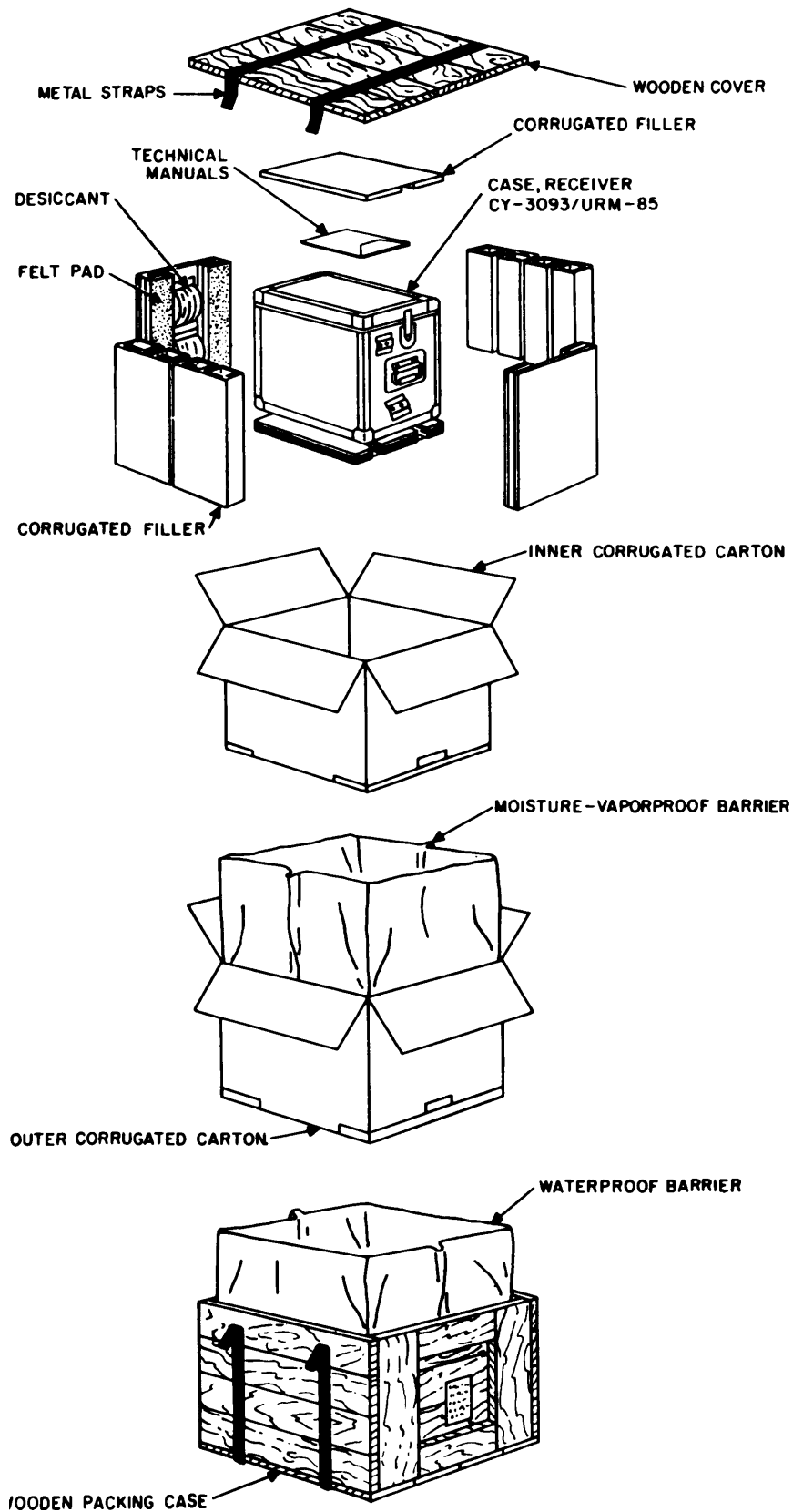

TM6625-351-12-6

Figure 9. Typical packaging.

13. Checking Unpacked Equipment

a. Inspect the equipment for damage incurred during shipment. If the equipment is damaged, refer to paragraph 2b.

b. Check the equipment against the packing list. If there is no packing list, use the table of components (para 5) and/or the

packaging data (para 12a) as a general check.

c. Be sure the proper fuses are in the fuseholder on the front panel of the main unit and the external transformer. The following chart shows the locations and values of the fuses.

| Reference Symbol | Fuse rating | | Component | Circuit | Location |
|------------------|-------------|-------|--------------------------------|---------------------------|------------------|
| | Amperes | Volts | | | |
| F701 | 2 | 250 | Main unit (fig. 11) | One leg of ac input line. | Front panel. |
| F801 | 2 | 250 | External transformer (fig. 13) | One leg of ac input line. | Rear of chassis. |

d. The main unit and the four tuning units are shipped with all fuses and electron tubes installed in their respective holders and sockets.

14. Placement of Equipment

a. *Unpacking.* Place the five transit cases, the transit chest, and the tripod storage bag near the equipment or site to be tested.

Warning: Never use the front panel handles (fig. 2) to transport the main unit when a tuning unit is installed. Doing so may result in withdrawing the tuning unit from its compartment and shifting the weight of the main unit suddenly, so that the main unit is dropped.

b. *Setting Up Main Unit.* Remove the cover from Case, Receiver CY-3093/URM-85, and insert the four legs to make a stand for the main unit (fig. 1). If the cover is difficult to remove, unscrew the air release valve on the cover to equalize air pressure.

Note. The equipment can be operated without being removed from the transit chest.

c. *Changing a Tuning Unit.* If the tuning unit installed in the main unit does not cover the frequency range to be measured (para 4a through d), exchange it with one of the tuning units supplied in each of the three Cases, Electronic Frequency Converter CY-3092/URM-85 (fig. 6). Otherwise, keep this tuning unit installed. The

handle at the left side of the tuning unit (fig. 2) is also used as a latching device. To remove an installed tuning unit from the main unit, pull the handle of the tuning unit forward while bracing the right side of the main unit. This will disengage the tuning unit latching device from the frame of the main unit. Pull the tuning unit forward to remove it completely from the compartment in the main unit. To install a different tuning unit, carefully slide the dust cover enclosing the tuning unit into the tuning unit into the empty compartment until a click is heard. This click indicates that the latching device, at the rear of the tuning unit handle, has engaged the frame of the main unit. No screws or nuts are required to be removed or replaced in the removal or installation procedure.

d. *Storing Unused Tuning Units.* Place the three unused tuning units in their transit cases, to avoid accidental damage to them.

e. *Setting Up Tripod.* Remove the tripod from the tripod storage bag and stand it up. Slide the adjustable legs along their wooden runners so that the top of the tripod is at a convenient height. Tighten the wing-bolts for the three legs to lock the tripod at this height. Make necessary adjustment to the legs so that the cylindrical masts at the center of the tripod are vertical (fig. 1).

f. *Locating Equipment for Noise Measurements.* When the equipment is used for noise measurements (para 18a), place it so that the appropriate antenna or probe

can reach the noise interference source when connected through the 30-foot length of rf cable. Refer to the applicable test specification for detailed measurements when locating the test set with respect to the equipment under measurement.

g. Locating Equipment for use as Rf Voltmeter, and for Noise or Carrier Field Intensity Measurements. The best location for this application of the equipment depends on the tactical situation and local conditions, such as the following: the need to place the equipment where it cannot be seen, the terrain, and the need for accessibility. The equipment may be located at any point outdoors, where it is desirable to make field strength measurements of noise or of a transmitter carrier. Better results are obtained when the equipment and antenna are away from such obstructions as trees, iron-frame buildings, or any objects that have conductive or inductive characteristics which produce undesired deviations from the measurement constants. Weak or otherwise undesirable signals may be expected if the equipment is operated under, or close to, steel bridges, underpasses, powerlines, or power units. If possible, select a location on a hilltop or high ground. Flat ground at the operating site is desirable. Normally, reception is better over water than over land.

15. Interconnections

(fig. 10)

Caution: Be sure the power switches on the external transformer (if used) and the main unit are set to OFF.

a. Operation From 120- Volt, 60- Cps Ac Supply. Connect the ac power cable from the POWER receptacle of the main unit directly to the ac outlet. If isolation of the test set from the powerlines is desired, such as in the presence of noise pickup from the ac outlet, use the external transformer (b below).

b. Operation from 120- Volt or 240- Volt, 50- to 400-Cps Ac Supply.

- (1) Set the 120 V-240V switch on the front panel of the external transformer (fig. 13) to 120V for 120-volt operation, or to 240V for 240-volt operation.
- (2) Plug the power cord on the external transformer into an ac outlet.
- (3) Connect the ac power cable from the POWER receptacle of the main unit to the A. C. OUTPUT receptacle on the external transformer.

c. Connections for Antennas, Couplers, and Probes. After the proper tuning unit has been installed in the main unit, determine the measurement to be made. For example, use the conductive couplers (para 20 and 21) for measuring the intensity of conducted noise on powerlines and audio-signal lines. Use the loop, vertical, or dipole antennas to measure the intensity of narrow-band (modulated or unmodulated cw) signals (para 22 and 24). Use the discone (broadband) antenna to measure the intensity of broadband (noise interference) signals (para 23 and 25). Use the magnetic field probes or the electric field probe to localize the source of noise interference from an electrical or an electronic piece of equipment (para 29). The following chart lists the cable connections shown in figure 10:

| Measurement to be performed | Signal pickup device employed | Cable or cord required | Connects | |
|---|--|--|--|---------------------------------------|
| | | | From | To |
| Intensity of conducted noise signals from powerlines or audio-signal lines. | Coupler, Radio Frequency Interference CU-891/URM-85, CU-892/URM-85, CU-896/URM-85, or CU-897/URM-85 (depending on frequency of signal and impedance of lines). | Rf cable (using only one of the two 30-foot cables in the taped pair). | N-type receptacle on the particular conductive coupler employed. | SIGNAL INPUT receptacle of main unit. |

| Measurement to be performed | Signal pickup device employed | Cable or cord required | Connects | |
|---|---|--|---|---|
| | | | From | To |
| Intensity of narrow-band (modulated or unmodulated cw) radiated signals. | a. Loop or vertical antenna (for use with tuning unit 1). | a. Rf cable (using <i>both</i> 30-foot cables in the taped pair). | a. Red color-coded N-type receptacle on antenna housing. Green color-coded N-type receptacle on antenna housing. | a. SIGNAL INPUT RECEPTACLE of main unit. IMPULSE OUTPUT receptacle of main unit. |
| | b. Dipole antenna (with proper balun for tuning unit 2, 3, or 4). | b. Rf cable (using only <i>one</i> of the two 30-foot cables in the taped pair). | b. N-type receptacle mounted on metal container at one end of balun. | b. SIGNAL INPUT receptacle of main unit. |
| Intensity of broadband (noise interference) radiated signals. | Discone (broadband) antenna. | Unbalanced injection block. | N-type receptacle at base of discone (broadband) antenna. | Noncolor-coded receptacle at one end of unbalanced injection block. |
| | | Rf cable (using <i>both</i> 30-foot cables in the taped pair). | Red color-coded N-type receptacle on unbalanced injection block. | SIGNAL INPUT receptacle of main unit. |
| Intensity of magnetic field component in localized noise interference signal. | One of the magnetic field probes, depending on frequency of signal under measurement. | Rf cable (using only <i>one</i> of the two 30-foot cables in the taped pair). | N-type receptacle at end opposite loop of probe. | SIGNAL INPUT receptacle of main unit. |
| Intensity of electric field component in localized noise interference signal. | Electric field probe. | Rf cable (using only <i>one</i> of the two 30-foot cables in the taped pair). | N-type receptacle at end opposite pickup disk of probe. | SIGNAL INPUT receptacle of main unit. |

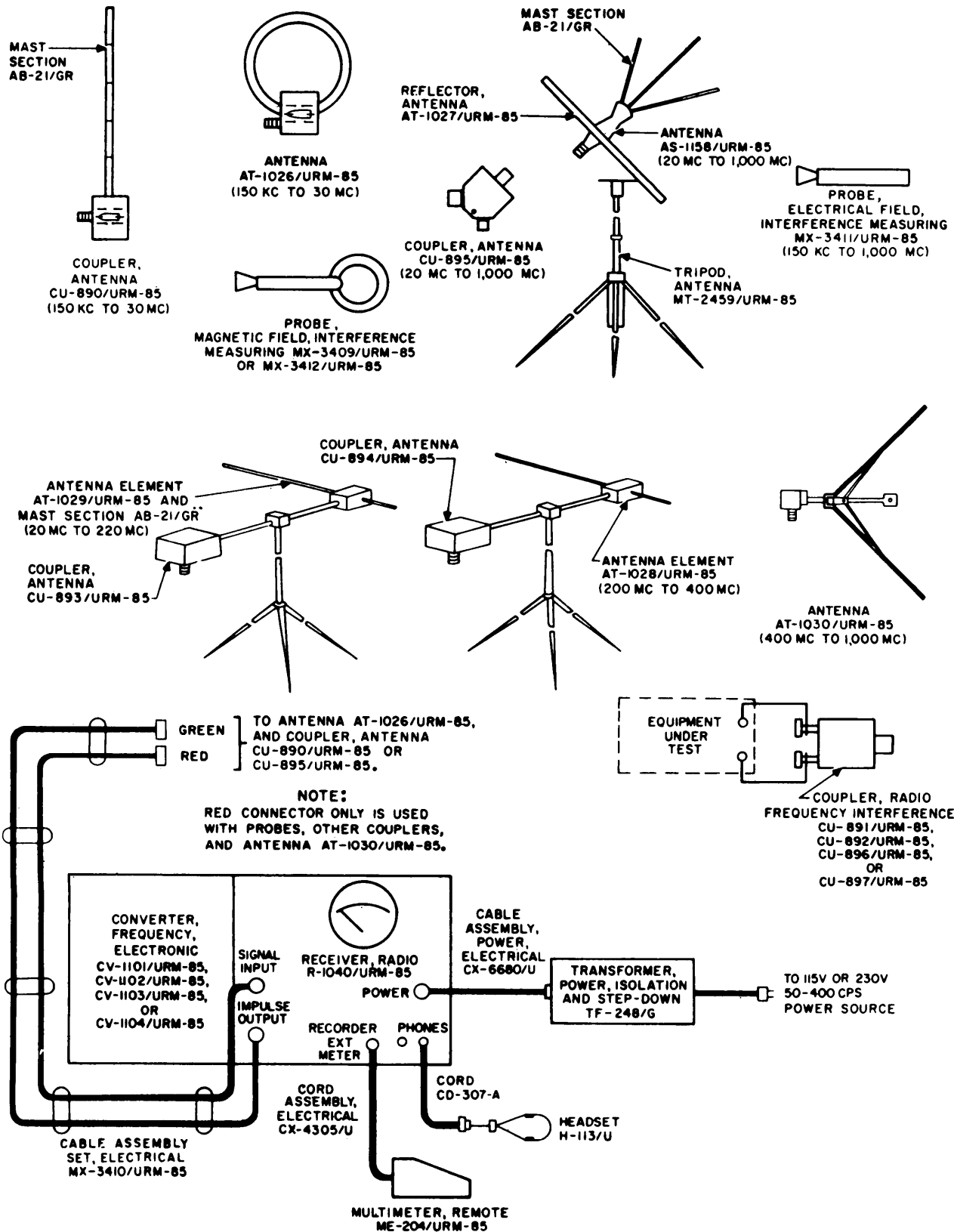

Figure 10. Interconnection diagram.

TM6625-351-12-7

Section II. OPERATOR'S CONTROLS AND INDICATORS

16. Damage From Improper Settings and Improper Mounting of Antennas

Observe the precautions in a through c below when setting the controls, and in d below when setting up the antennas.

a. Pull the SIGNAL ATTENUATOR DB knob and shaft outward from the front panel of the main unit before turning the knob. The use of excessive force in turning, without first pulling the knob and shaft back towards the operator, will damage the detent mechanism of this variable attenuator. After the white dot inscribed on the knob is lined up with any one of the six desired attenuator positions, push in the knob as far as possible towards the front panel.

b. Set the SIGNAL ATTENUATOR DB control at 80 to prevent damage to the panel-mounted meter (and remote meter, if used) when measurements are taken in an area known to have strong rf field intensities (above approximately 100,000 microvolts/meter). This precaution is required only when operating in the presence of intense rf power levels. Otherwise, follow the directions in paragraphs 19 through 30 for setting the SIGNAL ATTENUATOR DB control.

c. Set the 120V-240V switch on the external transformer (fig. 13) to 240V before connecting its integral power cable and connector to a 240-volt ac source. Failure to change the switch from the 120V to the 240V position, when connecting the transformer to a 240-volt ac outlet, will overload the transformer windings. To reset the switch, remove the slotted plate that serves as a switch guard from the front panel of the external transformer. After setting the switch to the desired 120V or 240V position, replace the switch guard-plate.

d. Use only the lowest of the three telescoping mast sections of the tripod when operating with the dipole antenna and reflector for tuning unit 4, or the vertical, loop, or discone (broadband) antenna. The two concentric mast sections are for raising the relatively lightweight dipole

antenna assemblies to a maximum height of 14 feet above ground.

Warning: Strong wind gust may tip over the larger antennas if they are elevated above the lowest tripod mast section, resulting in injury to personnel and damage to components.

17. Operating Controls, Indicators, and Jacks

a. Main Unit (fig. 11).

| Control, indicator, or jack | Function |
|---|--|
| POWER switch | Turns power to test set on or off. |
| Pilot lamp | Lights when POWER switch is set to ON and power is supplied to test set. |
| Function switch (5-position rotary switch). | Selects type of operation of meter. |
| | <i>Position Function</i> |
| | CW AVERAGE Enables meter to indicate average envelope voltage of narrow-band (modulated or unmodulated cw) signals. |
| | CW PEAK Enables meter to indicate peak envelope voltage of narrow-band (modulated or unmodulated cw) signals. |
| | ZERO ADJ. Permits meter pointer to be zeroed with ZERO ADJ. control. |
| | PULSE PEAK Enables meter to indicate peak envelope voltage of broadband (noise and pulsed) signals. |
| | METERED SLIDEBACK Provides a visual reference for slideback measurements (para 28). |
| ZERO ADJ. control. | Used to set meter pointer at zero before making tests. |
| VOLUME control | Adjusts audio level in headsets. |
| IMPULSE GENERATOR DB ABOVE 1 UV/MC (impulse generator controls): ON-OFF switch. | Turns impulse generator on or off. |

| Control, indicator, or jack | Function |
|--|--|
| Coarse output control (9-position rotary switch). | Varies output of impulse generator in 10-db steps (12 db total range). |
| Fine output control (12-position rotary switch). | Varies output of impulse generator in 1-db steps (12 db total range). |
| SIGNAL ATTENUATOR DB control (6-position rotary switch). | Provides five steps of attenuation, designated 0 CW ONLY, 20, 40, 60, and 80, for the rf or impulse noise signal. A sixth position, 0 SUBST. ONLY, provides zero attenuation when measuring unknown intensity of broadband interference by the signal substitution method of operation. |
| Calibration switch (2-position toggle switch). | In the SERIES CAL & OPERATE position, only the incoming rf signal, or the combined incoming rf signal plus the output of the impulse generator, is applied to the main unit. In the SHUNT CAL position, only the output of the impulse generator is applied to the input of the main unit. |
| METER DAMP. switch (3-position toggle switch). | In ON position or when held in depressed MOM. (momentary) position, provides electrical damping for the meter, when intermittent transients disturb steady meter indications. OFF position has no effect on meter indications. |
| DECIBELS-MICROVOLTS (meter). | Simultaneously indicates signal strength in db (with respect to 1 microvolt per mc) and microvolts. The db scale range is from -6 to -20; the microvolt scale from 0 to 10. Both ranges are extended by 20, 40, 60, or 80 db (equivalent to 100, 1,000, 10,000, or 100,000 microvolts, full-scale) by rotating the SIGNAL ATTENUATOR DB control to the corresponding panel-inscribed position. A further extension of the scale range by 40 db (equivalent to 10 volts full-scale) can be obtained by inserting Attneuator, Fixed CN-721/URM-85 between the SIGNAL input receptacle of the main unit and the red color-coded connector of the rf cable, with the SIGNAL ATTENUATOR DB control set at 80. |
| SIGNAL INPUT receptacle. | Couples incoming rf signal from signal pickup devices (para 9 through 11) through self-contained signal attenuator to input of tuning unit. |

| Control, indicator, or jack | Function |
|-----------------------------|---|
| IMPULSE OUTPUT receptacle. | Couples output of self-contained impulse generator to vertical, loop, or disccone (broadband) antenna when calibration switch set to SERIES CAL & OPERATE. |
| POWER RECEPTACLE | Couples 120-volt, 50- to 400-cps, ac power source to power supply circuits of test set. |
| RECORDER EXT METER jack. | Supplies dc signal to drive either a recording milliammeter or remote meter, when external indicating device is interconnected through remote meter cord to this jack. |
| PHONES jacks..... | Each of the two jacks supplies an audio signal to drive headsets. One headset can be used by the local operator, with his headset interconnected to the main unit through the short headset cord (5 ft 5 in.). A second headset can be used by the remote operator, with his headset interconnected to the main unit through the long headset cord (30 ft). |

b. *Turning Unit 1* (fig. 11).

| Control or indicator | Function |
|--|--|
| TUNING control | Tunes test set to receive signals from 150 kc (.15 mc) to 30 mc. |
| MEGACYCLES (frequency) dial. | Indicates frequency to which test set is tuned. |
| Bandawitch (6-position rotary switch). | Selects any of the six desired bands within the frequency range of the tuning unit. |
| GAIN control SLIDEBACK control. | Adjusts gain of test set. Provides a means of reducing both the received input signal, and the reference impulse generator output to the threshold of audibility. This achieves a high degree of discrimination between the monitored signal and interfering signals which may be present. |

c. Tuning Unit 2 (A, fig. 12).

| Control or indicator | Function |
|--|---|
| TUNING control . . . MEGACYCLES (frequency) dial. FREQUENCY RANGE-MC (bandswitch) switch (2-position rotary switch). GAIN control SLIDEBACK control. | Tunes test set to receive signals from 20 to 220 mc. Indicates frequency to which test set is tuned. Selects desired band within the frequency range of the tuning unit. The frequency range is divided into two bands. Adjusts gain of test set. Provides a means of reducing both the received input signal and the reference impulse generator output to the threshold of audibility. This achieves a high degree of discrimination between the monitored signal and interfering signals which may be present. |

d. Tuning Unit 3 (B, fig. 12).

| Control or indicator | Function |
|--|--|
| TUNING control . . . MEGACYCLES (frequency) dial. GAIN control SLIDEBACK control. | Tunes test set to receive signals from 200 to 400 mc. Indicates frequency to which test set is tuned. Adjusts gain of test set. Provides a means of reducing both the received input signal and the reference impulse generator output to the threshold of audibility. This achieves a high degree of discrimination between the monitored signal and interfering signals which may be present. |

e. Tuning Unit 4 (C, fig. 12).

| Control or indicator | Function |
|--|--|
| TUNING control . . . MEGACYCLES (frequency) dial. FREQUENCY RANGE-MC (bandswitch) switch (2-position rotary switch). GAIN control SLIDEBACK control. | Tunes test set to receive signals from 400 mc to 1,000 mc. Indicates frequency to which test set is tuned. Selects desired band within the the frequency range of the tuning unit. The frequency range is divided into two bands. Adjusts gain of test set. Provides a means of reducing both the received input signal and the reference impulse generator output to the threshold of audibility. |

| Control or indicator | Function |
|----------------------|--|
| | This achieves a high degree of discrimination between the monitored signal and interfering signals which may be present. |

f. External Transformer (fig. 13).

| Control or indicator | Function |
|---|---|
| Power switch 120V-240V switch (2-position toggle switch). AC OUTPUT receptacle. | Turns power to transformer on or off. Connects transformer for operation from either a 120-volt or 240-volt ac powerline. Connects output of external transformer to test set ac power cable. |

g. Vertical Antenna Base (fig. 3).

| Control or receptacle | Function |
|--|---|
| Bandswitch (6-position rotary switch). | Selects desired band within the frequency range of tuning unit 1. The six positions correspond to the six positions on the bandswitch for tuning unit 1. Set the bandswitch to the same position as the bandswitch on tuning unit 1 for proper impedance match. |
| Green color-coded receptacle. | Receives output of impulse generator, through mating green color-coded plug of rf cable. |
| Red color-coded receptacle. | Delivers rf signal to main unit through mating red color-coded plug of rf cable. |

h. Loop Antenna (fig. 3).

| Control or receptacle | Function |
|--|---|
| Bandswitch (6-position rotary switch). | Selects desired band within the frequency range of tuning unit 1. The six positions correspond to the six positions on the bandswitch for tuning unit 1. Set the bandswitch to the same position as the bandswitch on tuning unit 1 for a proper impedance match. |
| Green color-coded receptacle. | Receives output of impulse generator, through mating green color-coded plug of rf cable. |
| Red color-coded receptacle. | Delivers rf signal to main unit through mating red color-coded plug of rf cable. |

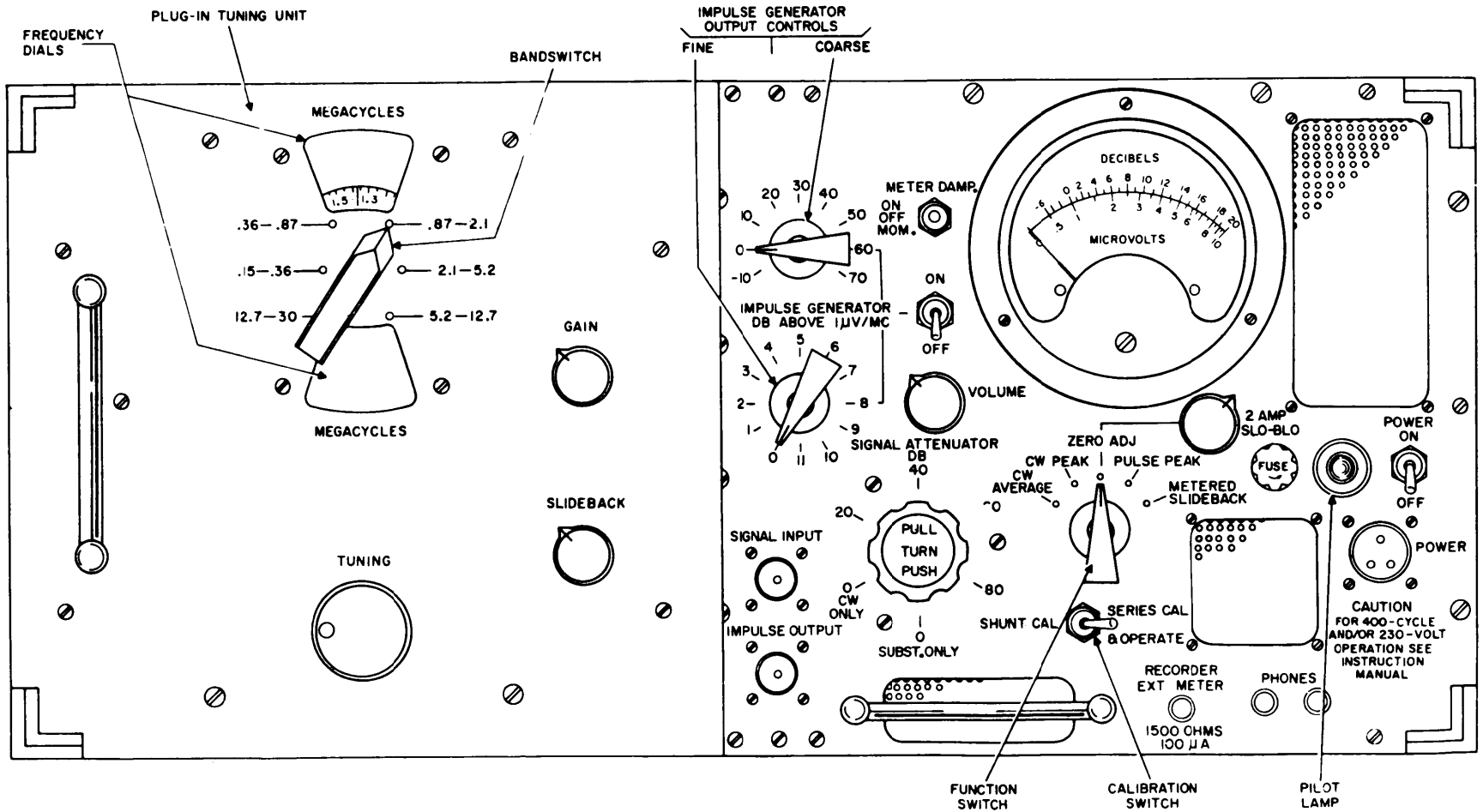

TM6625-351-12-8

Figure 11. Main unit and tuning unit 1, operating controls and indicators.

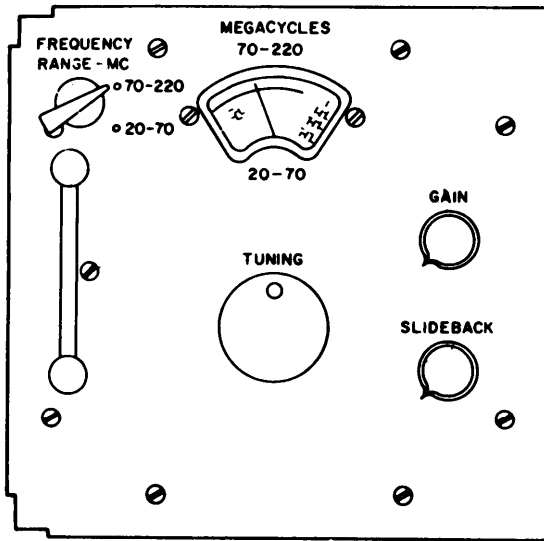

TUNING UNIT 2
A

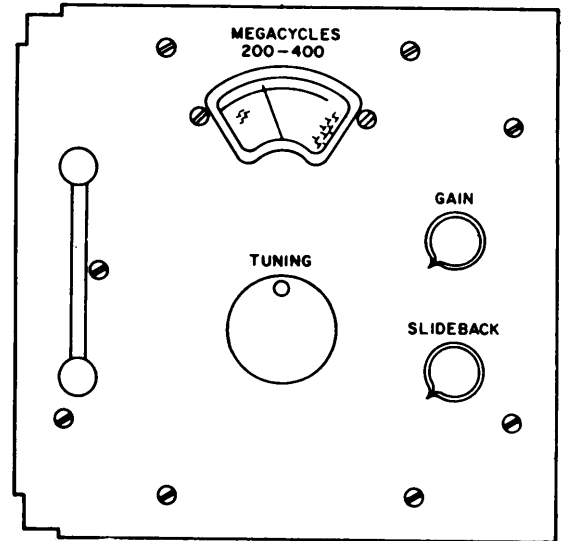

TUNING UNIT 3
B

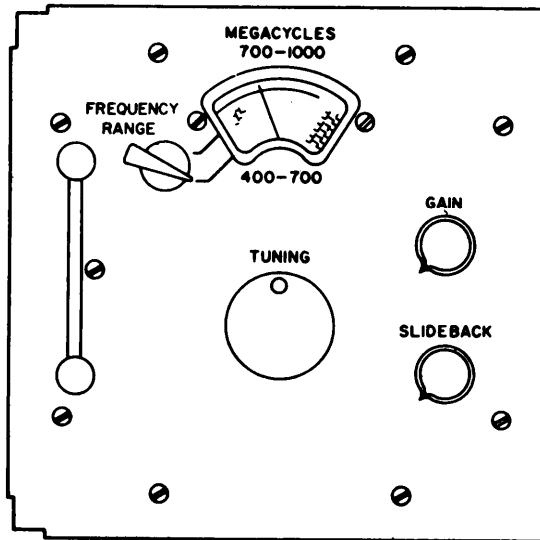

TUNING UNIT 4
C

TM6625-351-12-9

Figure 12. Tuning units 2, 3, and 4, operating controls and indicators.

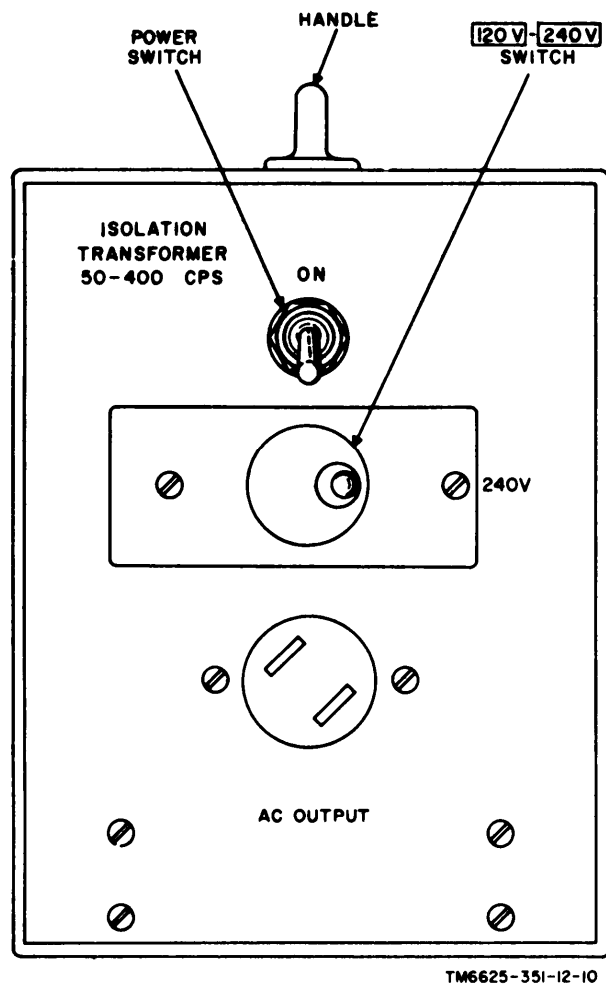

Figure 13. External transformer, operating controls.

Section III. OPERATING INSTRUCTIONS

18. Types of Operation

a. Applications. The test set may be operated to measure the intensity of broadband noise interference ((1) below), to measure the field intensity of broadband noise ((2) below), to function as a tunable rf voltmeter ((3) below), or to measure the field intensity of narrow-band (modulated or unmodulated cw) signals ((4) below).

- (1) *Measuring intensity of broadband noise interference.* The unit of measurement is in terms of microvolts-per-megacycle bandwidth. The noise signal may be applied to the input of the test set by the radiated method of coupling (when using

the discone (broadband), loop, or vertical antenna), by the inductive method of coupling (when using the magnetic or electric field probes), or by the conductive method of coupling (when using the 50-ohm and 500-ohm conductive couplers).

- (2) *Measuring field intensity of broadband noise.* The unit of measurement is in terms of microvolts-per-megacycle bandwidth per meter. In this application, only the appropriate dipole antenna (for use with tuning units 2 through 4) and the vertical or loop antenna (for use with tuning unit 1) are employed in the radiated method of coupling.

(3) *Functioning as tunable rf voltmeter for narrow-band signals.* The unit of measurement is in terms of microvolt. The application is similar to that of a conventional ac or direct-current (dc) voltmeter, in which the amplitude of a given potential is measured across two terminals. Usually, one terminal is at a potential which is positive or negative with respect to a reference value; the other terminal is at the reference value. This test set is capable of serving as a tunable rf voltmeter for modulated or unmodulated cw signals from 150 kc to 1,000 mc, if each of the following conditions is met:

- (a) The proper tuning unit, corresponding to the frequency range of the signal under measurement, is installed in the main unit.
- (b) The frequency dial of the tuning unit is set to the exact frequency of the carrier signal under measurement.
- (c) The output connector of the signal source, such as a radio receiver a tuned rf amplifier, a signal generator, or a local oscillator, has 50-ohm impedance to match the input impedance of the test set in all positions of the SIGNAL ATTENUATOR DB control except the 0 SUBST. ONLY position.
- (d) The coupling device used to feed the signal from the signal source to the input of the test set is 50 ohms impedance. Wherever possible, use the red color-coded rf cable in Cable Assembly Set, Electrical MX-3410/URM-85, because this cable has the proper impedance characteristics. If the signal source is terminated in a BNC-type coaxial connector, use the appropriate adapter to convert the BNC connector to a N-type termination, so the red color-coded cable in the pair of rf cables supplied can be used. As another example of adapting a BNC termination on

the signal source to a usable output, use BNC male-to-binding-post Adapter Connector UG-641/U (not supplied). This adapter will require fabrication of a proper rf cable with a 50-ohm characteristic impedance, with one end of the cable stripped and tinned to mate the binding-post connection. Use a N-type connector at the main unit end of the cable, to mate the SIGNAL INPUT receptacle on the main unit.

- (4) *Measuring field intensity of narrow-band signals.* The unit of measurement is in terms of microvolt per meter. When operating over the frequency range of tuning units 2 through 4 (20 mc to 1,000 mc), the appropriate antenna is used in the radiated method of coupling. In operating over the frequency range of tuning unit 1 (150 kc to 30 mc), either the loop or the vertical antenna is used in the radiated method of coupling.

b. Calibration Methods. The method of calibrating the test set depends on the application of the test set (a above) and the characteristics of the pickup device. The two methods of calibrating the test set are as follows:

- (1) *Shunt Calibration* (fig. 14 and 15). When calibrating the test set by following the shunt method, either the output of the impulse generator or the external rf signal under measurement is applied to the metering circuit. This transfer of signal is accomplished by the calibration switch. When set to SHUNT CAL, the switch provides an internal signal path through a fixed 20-db attenuator for the known amplitude output of the impulse generator. The settings of the impulse generator coarse and fine output controls, to produce a full-scale deflection at the frequency under measurement, can be determined from figures 19 and 20. The calibration switch is then set to SERIES CAL & OPERATE, so the

rf signal under measurement causes an on-scale meter pointer deflection. Shunt calibration is used in the sense that the output of the impulse generator and the external rf signal under measurement are essentially in parallel, with respect to the input terminals of the test set. The calibration switch permits the operator to select either one or the other signal.

- (2) *Series calibration* (fig. 16 through 18). The vertical antenna, loop antenna, and discone (broadband) antenna require the series method of calibration. In this method, the calibration switch must be set to SERIES CAL & OPERATE. This setting creates a circuit path which enables the output of the impulse generator to flow through an attenuating network which is housed in different physical areas, depending on the pickup device in use. For the vertical antenna (fig. 16) and loop antenna (fig. 17), the attenuating network is housed in the antenna base. For the discone

(broadband) antenna (fig. 18), the attenuating network is housed in the unbalanced injection block. In all cases, the network attenuates the output of the impulse generator by a ratio of 20 db, and couples the attenuated output of the impulse generator in series with the incoming rf signal. The receiver is calibrated by comparing two indications. One indication is obtained by observing the intensity of the incoming rf signal, with the impulse generator ON-OFF switch at OFF. The second indication is obtained by making the source of the incoming rf signal inoperative and energizing the impulse generator by setting the impulse generator ON-OFF switch at ON. The receiver is calibrated by setting the impulse generator output controls to produce the same meter pointer deflection as that produced by the incoming rf signal.

Note. If the source of the rf signal cannot be shut down, refer to paragraph 25g for an alternate procedure.

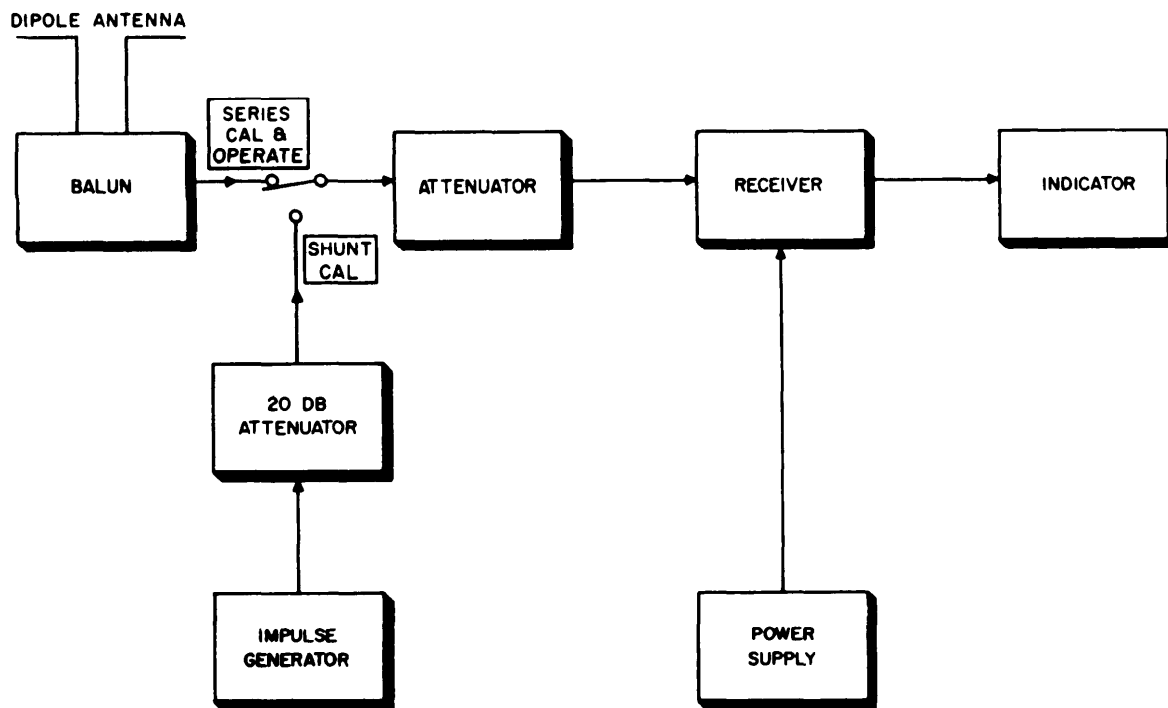
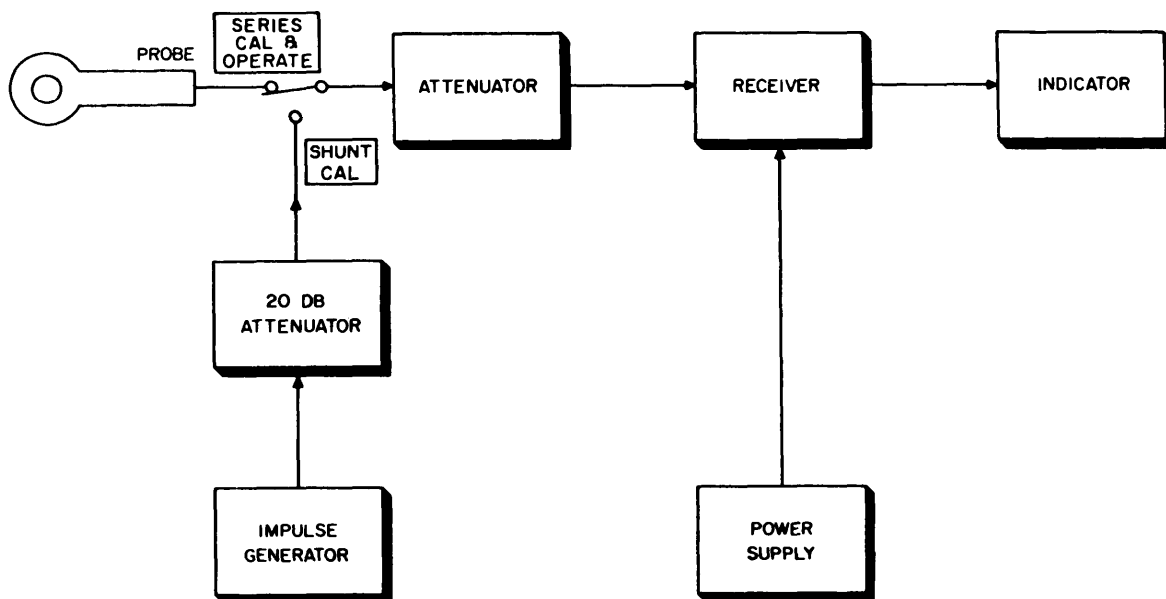

Figure 14. Shunt calibration, using dipole antenna.



TM6625-35I-12-12

Figure 15. Shunt calibration, using probes.

c. Basic Measuring Methods. Essentially, two basic measuring methods, the direct reading and the substitution, are employed. Broadband (noise measurements are made by the direct reading method, because the incoming signal and the output of the impulse generator are broadband in nature. Narrow-band (cw) measurements are made by the substitution method, because the bandwidth of the test set must be considered at a particular frequency.

- (1) *Direct reading method.* To setup the test set for direct reading, the known-amplitude output of the impulse generator is applied to the main unit. The GAIN control is set to produce a full-scale deflection on the panel-mounted meter, the impulse generator is turned off, and the signal under measurement is applied to the test set. The meter pointer deflection is read directly from the calibrated meter scale.

Note. Narrow-band (cw) signals are measured by the direct reading method, except that a graph must be referred to when using the dipole antennas (fig. 23) or when using either the loop or vertical antenna (fig. 24). The graph shows a correction

factor for bandwidth at a particular frequency. This factor must be considered in the final calculation.

- (2) *Substitution method.* To set up the test set for the substitution method, the unknown-amplitude incoming rf signal is applied to the test set and the meter indication is observed. (This indication may be visual, by referring to the meter pointer deflection (para 28), or aural, by using the slideback technique (para 27).) The incoming rf signal is then disconnected and the output of the impulse generator is applied to the test set. The output controls of the impulse generator are set to a level that produces the same indication as the incoming rf signal. The level of the signal is read by referring to the calibration marks inscribed on the front panel at these settings of the impulse generator output controls.

d. Procedure. For any type operation, perform the following procedures:

- (1) Starting and calibrating procedures (para 19).

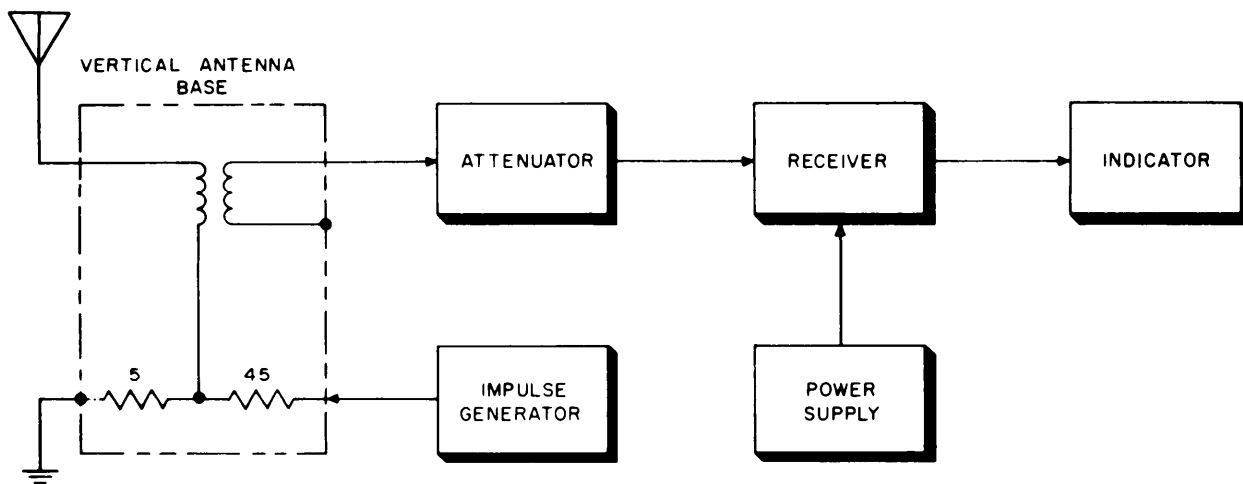

TM6625-351-12-13

Figure 16. Series calibration, using vertical antenna.

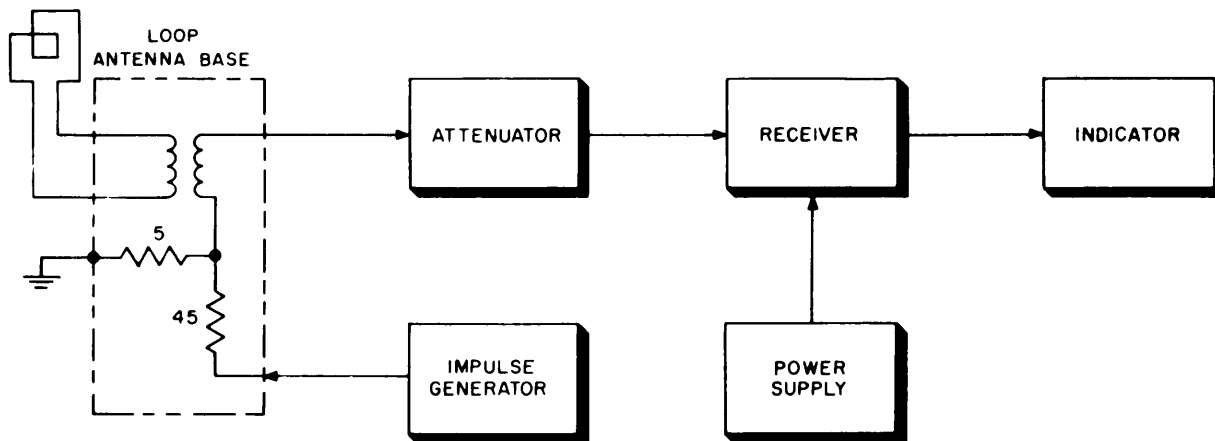

TM6625-351-12-14

Figure 17. Series calibration, using loop antenna.

(2) Procedure for the desired measurement, which depends on the following:

- (a) Whether the measurement is taken across powerlines or audio-signal lines (para 20 and 21).
- (b) Whether the measurement is taken in the near field or the far field of the radiating antenna (para 22 through 25).
- (c) Whether more than one level of signal is present at one frequency (para 26).
- (d) Whether the slideback technique

is used in the substitution method of measurement (para 27 and 28).

- (e) Whether the test set is being used to pinpoint the source of rf interference (para 29).
- (f) Whether the field intensity of narrow-band (carrier) signals is under measurement (para 30 and 31).

(3) Stopping procedure (para 32).

e. Summary. The application of the test set, the pickup device to be used, the method of calibration, the basic method of measurement, and the type of indication are summarized in the following chart.

| Application and units of measurement | Pickup device | Coupling device | Calibration method | Basic method of measurement | Indication |
|---|--|--|--|---|---|
| Broadband noise measurements (in microvolts per-megacycle bandwidth). | Discone (broadband) antenna (fig. 4). Loop or vertical antenna (fig. 3). | Unbalanced injection block and pair of rf cables. Pair of rf cables. | Series (para 18 b(2)). | Direct reading (para 18c (1)) or substitution (para 18c (2)). | Meter (para 20-26 and 29-31) or slideback (para 27 and 28). |
| Broadband noise field intensity measurements (in microvolts per-megacycle bandwidth per meter). | Dipole antennas (fig. 1 and 4). Loop or vertical antenna. | Red color-coded rf cable. Pair of rf cables. | Shunt (para 18b (1)). Shunt..... Series..... | Direct reading or substitution. | Meter or slideback. |
| Two-terminal rf voltmeter for narrow-band signals (in microvolts). | Not supplied; the signal is applied to the test set direct from the signal source. | Red color-coded rf cable, or a fabricated cable if the signal source is not equipped with a 50-ohm N-type coaxial connector. | Shunt..... | Direct reading. | Meter. |
| Narrow-band field intensity measurements (in microvolts per meter.) | Dipole antenna. Loop or vertical antenna. | Red color-coded rf cable. Pair of rf cables. | Shunt..... Series..... | Direct reading. | Meter. |

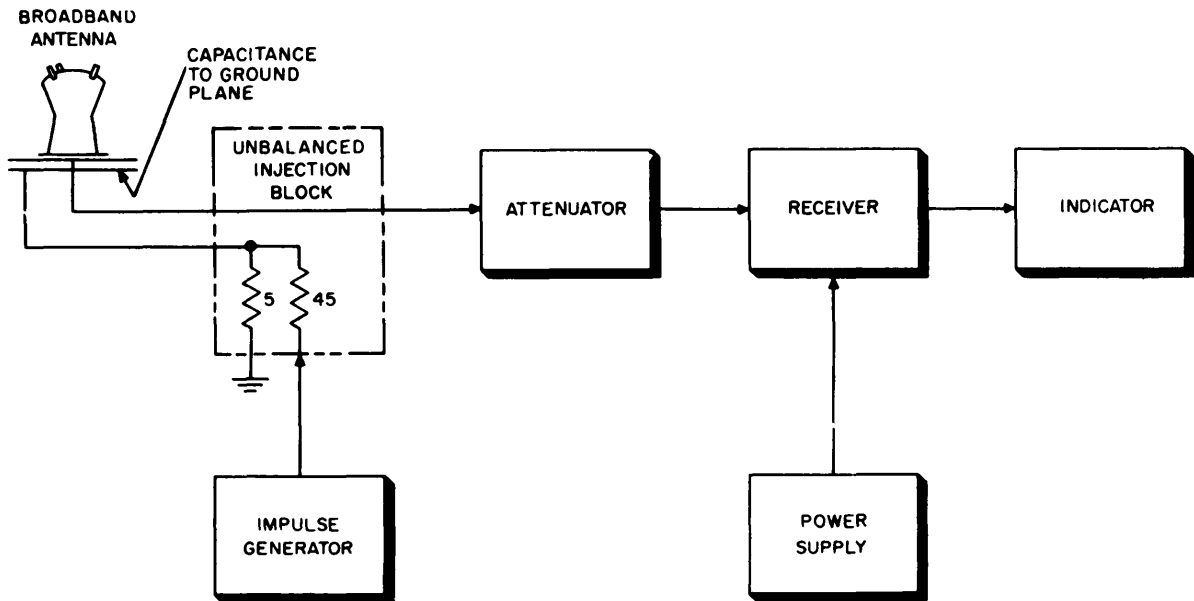

TM6625-351-12-15

Figure 18. Series calibration, using discone (broadband) antenna.

19. Starting and Calibrating Procedures

Note. If an abnormal indication is obtained during either the starting or calibrating procedure, refer to the equipment performance checklist (para 48) for corrective measures.

a. Starting Procedure. Check to see that the equipment has been properly set up for operation (para 14) and that the various major and minor components are interconnected as shown by the chart in paragraph 15c. After this check has been made, perform the procedures in (1) through (5) below.

- (1) Be sure that the POWER switch on the main unit is at OFF, and that the correct tuning for the desired frequency to be received is in place (para 4).
- (2) Turn the VOLUME and GAIN controls fully counterclockwise.
- (3) Plug a headset into one of the PHONES jacks.

Note. Two headsets may be used simultaneously if two operators desire to monitor aural indications at the same time. For example, one operator may work near the main unit by using the short headset cord. A second operator may work at a remote point (up to 30 feet from the main unit) by using the long headset cord.

- (4) If the external transformer is used, set its POWER switch to ON.
- (5) Set the POWER switch to the main unit to ON and allow a 15-minute warmup.

b. Calibration Procedure.

Caution: Pull out the SIGNAL ATTENUATOR DB knob (fig. 11) before turning it. Turning the knob without first pulling it forward will damage the attenuator. After the dot on the knob is lined up with the desired position, push the knob all the way in.

- (1) Set the front panel controls as follows:

| Control | Position |
|----------------------------------|-----------|
| Function switch | ZERO ADJ. |
| Impulse generator ON-OFF switch. | OFF. |

| Control | Position |
|--|---|
| SIGNAL ATTENUATOR DB. | Use the 20 position when operating in the frequency range of tuning units 2, 3, and 4. Use the 0 CW ONLY position when operating in the frequency range of tuning unit 1. Use the 0 SUBST. ONLY position for broadband signal substitution measurements. |
| Calibration switch | SHUNT CAL. |
| METER DAMP. switch | OFF. |
| SLIDEBACK control (on tuning unit). | Fully counterclockwise. |

- (2) Adjust the ZERO ADJ. control until the meter pointer is at 0 on the MICROVOLTS scale.
- (3) Set the function switch to PULSE PEAK when taking broadband measurements, or to CW PEAK when taking narrow-band measurements.
- (4) When using tuning units 1, 2, and 4, set the bands witch on the front panel to the desired band of frequencies (para 4) to be received. Omit this step when using tuning unit 3; it has no bandswitch.
- (5) Set impulse generator coarse and fine output controls (fig. 11) as follows:
 - (a) For narrow-band measurements, refer to the two-terminal voltmeter chart in the calibration book, supplied with each test set. (See figures 19 and 20 for typical charts.) Obtain the impulse generator output setting for the desired frequency; then set the impulse generator coarse and fine output controls accordingly.
 - (b) For broadband measurements, set the impulse generator coarse control to 60 and the fine control to 0. Use these settings for all frequencies to be measured.
- (6) Set the impulse generator ON-OFF switch to ON.
- (7) Adjust the GAIN control for a full-scale reading on the meter.

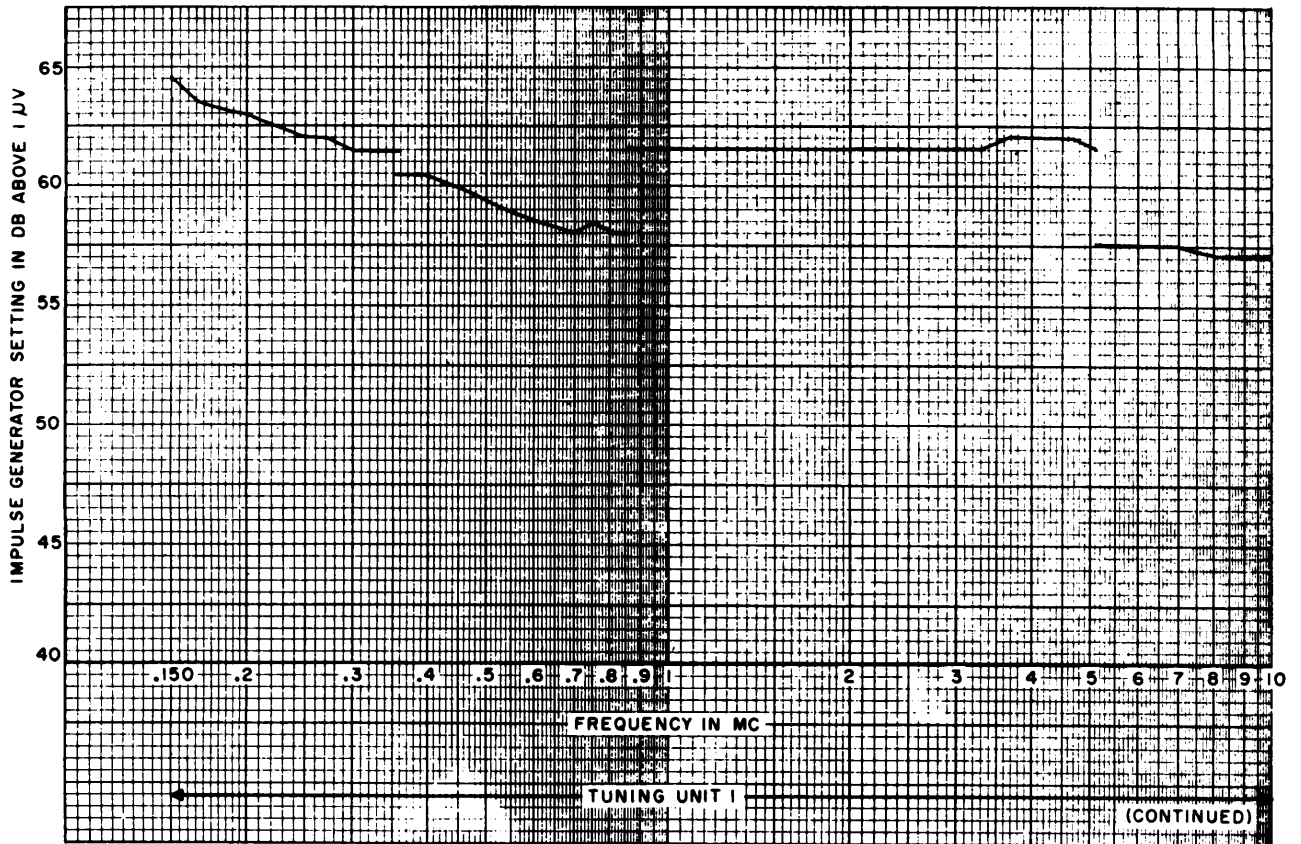

TM6625-351-12-17

Figure 19. Typical two-terminal voltmeter chart, 0.150 mc to 10 mc.

- (8) Set the impulse generator ON-OFF switch to OFF.
- (9) When operating over the frequency range of tuning unit 2, 3, or 4, the test set is now calibrated (*for the particular frequency under measurement*) to produce a full-scale meter deflection of 40 db above 1 microvolt, which is equivalent to 100 microvolt. Do not disturb the setting of the GAIN control until after a measurement is completed. To measure a signal at a different frequency from 20 to 1,000 mc, recalibrate the test set at this new frequency by repeating the procedure in (3) through (8) above.
- (10) When operating over the frequency range of tuning unit 1, the SIGNAL

ATTENUATOR DB control has been set to 0 CW ONLY. Therefore, the test set is calibrated (*for the particular frequency under measurement*) to produce a full-scale meter deflection of 20 db above 1 microvolt, which is equivalent to 10 microvolt. Do not disturb the setting of the GAIN control until after a measurement is completed. To measure a signal at a different frequency from 150 kc to 30 mc, recalibrate the test set at this new frequency by repeating the procedure in (3) through (8) above. at a different frequency from 150 kc to 30 mc, recalibrate the test set at this new frequency by repeating the procedure in (3) through (8) above.

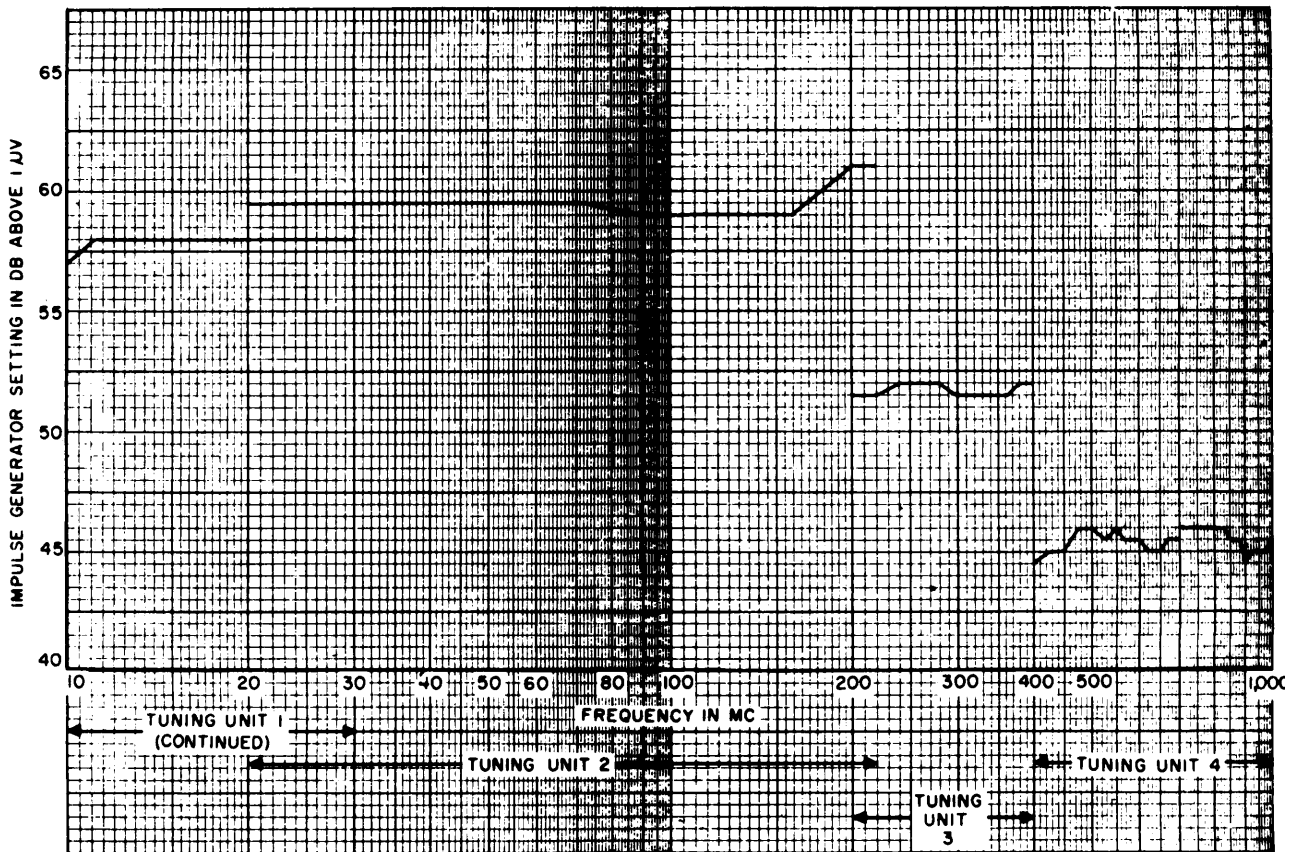

TM6625-351-12-18

Figure 20. Typical two-terminal voltmeter chart, 10 mc to 1,000 mc.

20. Measurement of Narrow-Band Conducted Signals

Coupler, Radio Frequency Interference CU-891/URM-85, CU-892/URM-85, CU-896/URM-85, or CU-897/URM-85 is used to measure narrow-band (modulated or unmodulated) cw signals conducted in wire circuits, such as power lines and audio-frequency lines. Measure narrow-band conducted signals as follows:

Caution: Do not connect the conductive couplers across a source of more than 500 volts, to avoid breakdown of the capacitors within the couplers. Use a voltage divider when taking measurements on high-voltage powerlines and audiofrequency lines, so that the input to the couplers is 500 volts or less.

a. Start and calibrate the test set (para 19).

b. Set the calibration switch to SERIES CAL & OPERATE and the function switch to CW AVERAGE.

c. Attach the red connector at one end of the rf cable to the SIGNAL INPUT receptacle of the test set (fig. 10). Attach the red connector at the other end of the rf cable to the jack on the appropriate 50-ohm conductive coupler, if a low-impedance line circuit is to be measured. If the impedance of the lines is higher than 150 ohms, use the appropriate 500-ohm coupler.

Note. If the impedances of the circuit under test is unknown, make the test with both the 50-ohm and 500-ohm couplers. Use the higher of the two readings. Note which coupler gave the higher resolving in any tabulation of the results.

d. connect the binding posts at the opposite end of the coupler to the line under test. Use the shortest possible leads.

e. Note the meter reading. If the meter pointer deflects off-scale at the right end, set the SIGNAL ATTENUATOR DB control to successively higher steps (such as 40, 60, 80) until an on-scale meter reading is obtained. If the pointer is still off-scale with the attenuator set at 80, insert ATTENUATOR, FIXED CN-721/URM-85 (external pad) between the rf cable and the SIGNAL INPUT receptacle. This fixed attenuator extends the range of the meter by 40 db.

f. If the meter pointer indicates less than 0 on the db scale, set the SIGNAL ATTENUATOR DB control to 0 CW ONLY. If the meter still indicates less than 0 db, the required measurement is outside the range of the test set.

g. It is possible that the meter will indicate more than 0 db because of electron tube noise generated within the test set. This noise may be due to electron emission, ionization by collision of electrons, or an imperfection in electron tube construction. Set the calibration switch to SHUNT CAL. If the meter indication changes, refer to b below. If the meter indication does not change, the meter is being actuated by electron tube noise, and no signal is being received. Check all cable connections (para 15c) and control settings (para 17). If no signal is being received, and all necessary adjustments have been made, refer to the equipment performance checklist (para 43) for corrective measures.

h. If the meter indication drops more than 6 db when the calibration switch is moved from SERIES CAL & OPERATE to SHUNT CAL, the original meter reading is good. Use the original meter reading to calculate the level of the signal being measured. If the meter indication is not good (because the meter reading drops less than 6 db), a correction factor must be applied (fig. 21). Compute the true signal level as "follows:

- (1) From the first meter reading, which is signal plus noise (S + N), subtract the internal noise reading (N) indicated with the calibration switch at SHUNT CAL. The result is S + N minus N.

- (2) Locate this resultant on the horizontal axis of the chart (fig. 21). Proceed vertically until the curve is intersected, then proceed horizontally to the left edge of the chart. Subtract the reading in db above 1 microvolt (UV) just obtained from the chart from the first meter reading (S + N).

- (3) The difference is the true signal level in db above 1 microvolt when using the 50-ohm coupler.

Note. Add 26 db to the difference obtained in (2) above when using the 500-ohm coupler.

- (4) Use the result as the meter reading to calculate the level of the signal being measured.

- i. Calculate the level of the signal being measured, in db above 1 UV, by adding the following:

Meter reading in db+ SIGNAL ATTENUATOR DB control setting in db + 0 db for 50-ohm coupler, 26 db for 500-ohm coupler, or 40 db if external pad is used, + db loss in rf cable (fig. 22).

Example:

| | |
|---|--------------|
| Meter reading | 12 db |
| SIGNAL ATTENUATOR DB control (assumed setting) | 40 db |
| 50-ohm coupler | 0 db |
| or | |
| 500-ohm coupler | 26 db |
| Rf cable loss (30 ft RG-5B/U) | 1 db |
| External pad not used | 0 db |
| Total . . . | 79 db |

In the above total, it is assumed that the 500-ohm coupler was used. If the 50-ohm coupler was used, the signal level would be 79 db -26 db, or 53 db above 1 UV.

- j. Repeat the procedures in a through i above for each frequency to be measured.

21. Measurement of Broadband Conducted Signals

Couplers, Radio Frequency Interference CU-891/URM-85, CU-892/URM-85, CU-896/URM-85, and CU-897/URM-85 are

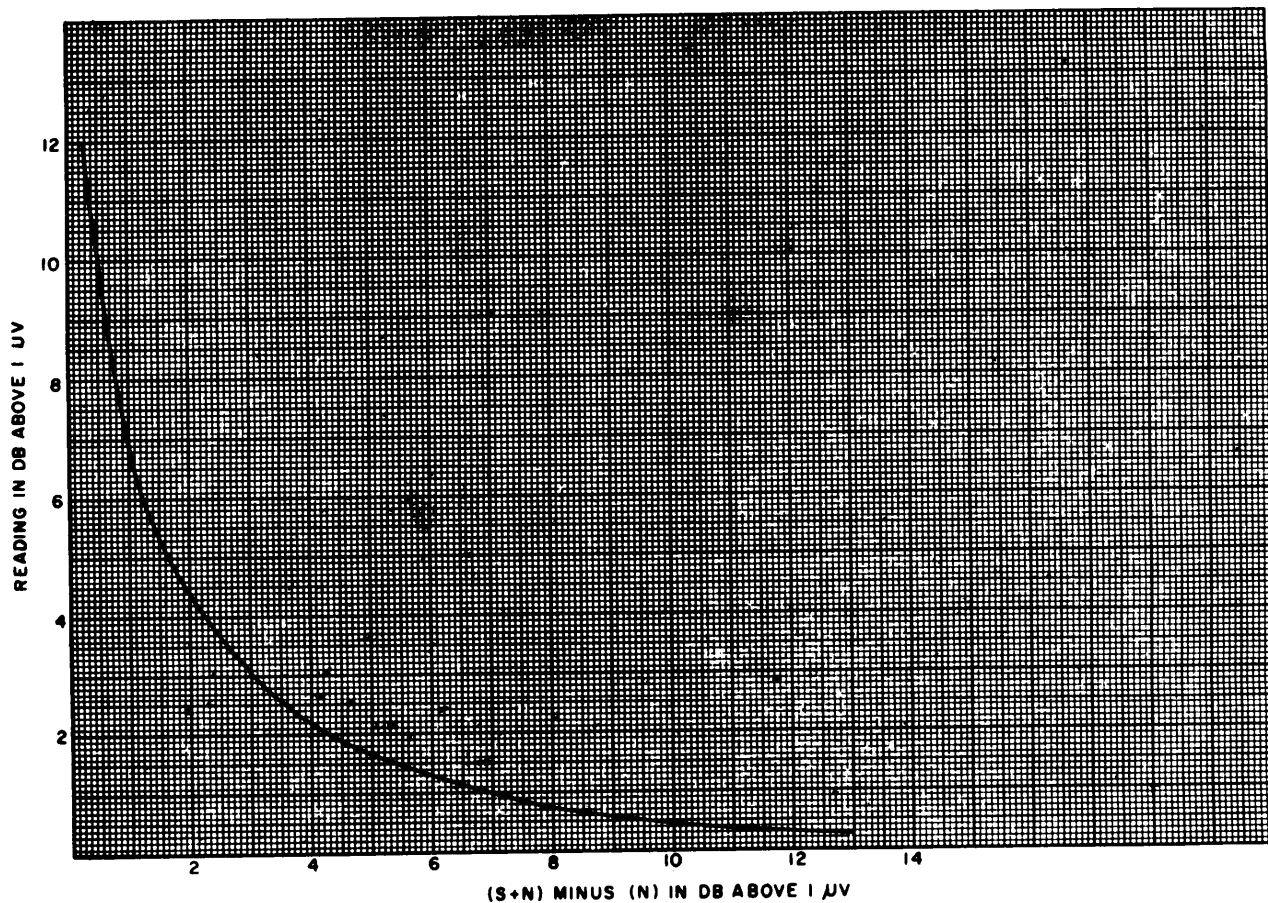

TM6625-351-12-16

Figure 21. Computation chart for signal in presence of noise.

used to measure broadband (noise) rf signals conducted in wire circuits, such as powerlines and audiofrequency lines. For this application, each conductive coupler has a constant 20-db loss, which must be considered in the final calculation. Measure broadband conducted signals as follows:

- a. Start and calibrate the test set (para 19).
- b. Set the calibration switch to SERIES CAL & OPERATE and the function switch to PULSE PEAK.
- c. Perform the procedure in paragraph 20c through e.
- d. Perform the procedures in paragraph 20f through h, if applicable, to obtain the true signal level.

e. Calculate the level of the signal being measured in db above 1 uv/mc by adding the following:

20 db constant + meter reading in db + SIGNAL ATTENUATOR DB control setting in db + 0 db for 50-ohm coupler, 26 db for 500-ohm coupler, or 40 db If external pad is used, + db loss in rf cable (fig. 22).

Example:

| | |
|----------------------------------|--------------|
| Constant | 20 db |
| Meter reading | 12 db |
| SIGNAL ATTENUATOR DB | |
| control setting | 20 db |
| 50-ohm coupler | 0 db |
| or | |
| 500-ohm coupler | 26 db |
| Rf cable loss (30 ft RG- | |
| 5B/U). | 1 db |
| Total | <u>79 db</u> |

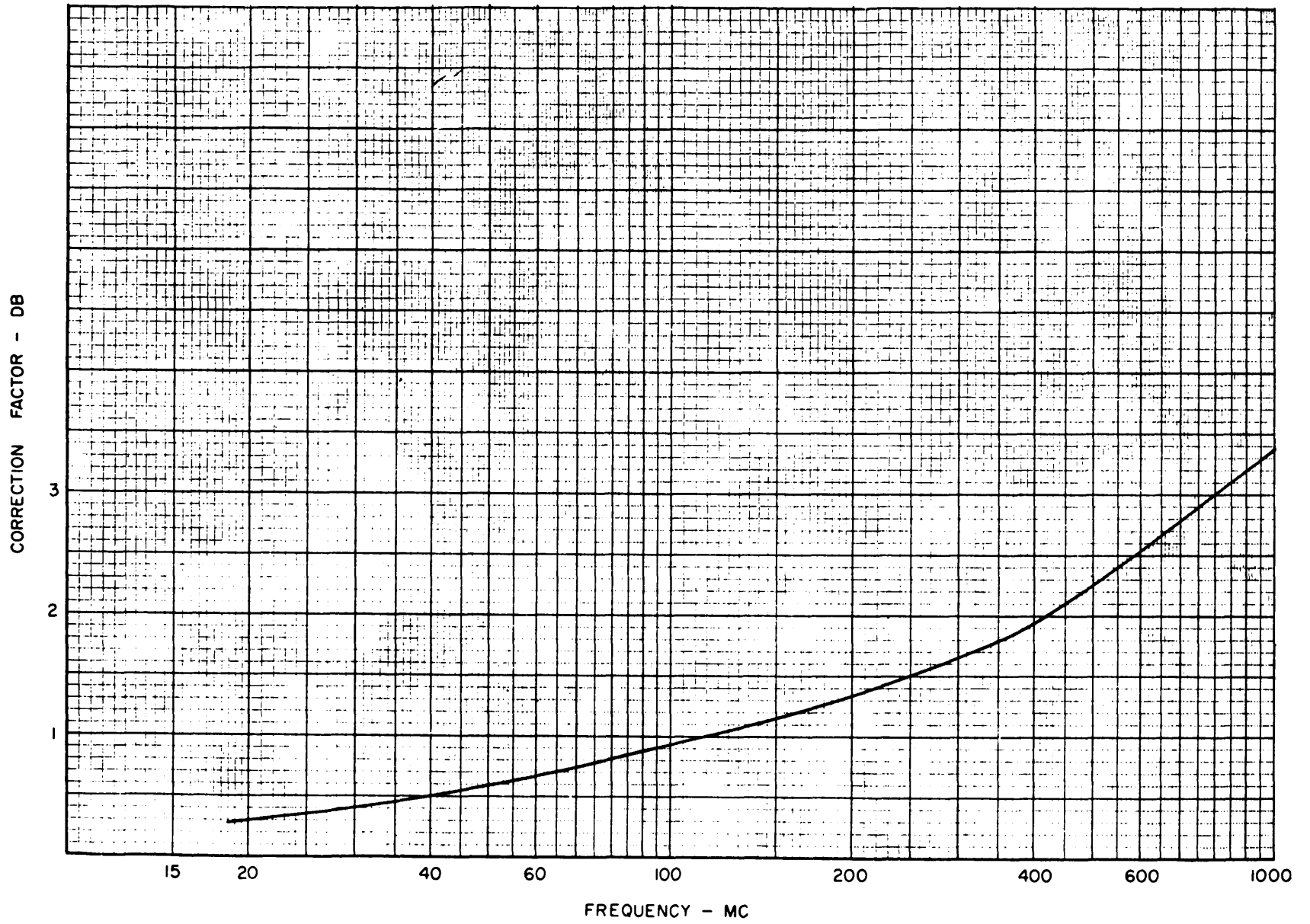

Figure 22. Correction chart for rf cable loss (30 ft RG-5B/U).

TM6625-351-12-19

In the above total, it is assumed that the 500-ohm coupler was used. If the 50-ohm coupler was used, the signal level would be 79 db -26 db, or 53 db above 1 uv/mc.

f. Repeat the procedures in a through e above for each frequency to be measured.

22. Narrow-Band, Far-Field Measurements

In the operating procedures in paragraphs 22 through 25, a distinction is made between *far-field* and *near-field* measurements. The boundary line between a radiating antenna's far field and near field may be located by substituting values in the formula

$$R = \frac{2L^2}{\lambda} \text{ where } R = \text{radius from antenna}$$

L = physical length of the radiating antenna

λ = wavelength of the signal

The far field is the area outside this imaginary boundary line around the radiating antenna. The near field is the area within this imaginary boundary line. For example, assume that a 30-mc signal (which has a wavelength of 10 meters) is radiated from a resonant dipole antenna having a length of 4.75 meters (1 meter equals 39.37 inches). Apply these figures to the formula

$$R = \frac{2 (4.75)^2}{10}$$

$$R = \frac{2 (22.56)}{10}$$

$$R = \frac{45.12}{10} = 4.5 \text{ meters}$$

Therefore, the boundary line for this example between the far field and the near field of the radiating antenna is 4.5 meters (approximately equivalent to 13.5 feet). Measure the field strength of narrow-band

(modulated or unmodulated cw) signals in the far field as follows:

a. Start and calibrate the test set (para 19).

b. Set up the tripod at any convenient distance up to 30 feet from the test set.

c. Depending on the frequency to be measured, mount the correct antenna on the tripod.

(1) For frequencies between 150 kc and 30 mc (tuning unit 1), use the loop or vertical antenna (fig. 10). Use only the lowest of the three telescoping masts on the tripod to lock the antenna in place on the mounting facilities. Use the loop antenna when measuring relatively strong rf signals. This antenna can be rotated on its swivel joint to give information on the direction of the incoming signal. Always rotate the loop through 180° to obtain the maximum pointer deflection on the meter. If the signal under measurement is so weak that no meter indication can be obtained with the loop antenna, use the vertical antenna with six series-connected -- Mast Sections AB-21/GR inserted in its socket. Be sure to secure the vertical antenna base to the facilities on the ground plane, and mount the combined ground plane with the vertical antenna on the tripod mast.

(2) For frequencies between 20 and 220 mc (tuning unit 2), use Coupler, Antenna CU-893/URM-85 (fig. 4), the required number of Mast Sections AB-21/GR when operating over the lower frequency range from 20 to 70 mc, and the telescopic antenna element in d below.

Note. No Mast Sections AB-21/GR are required when operating the test set over the higher frequency range of tuning unit 2 from 70 to 220 mc.

(3) For frequencies between 200 and 400 mc (tuning unit 3), use Coupler, Antenna CU-894/URM-85 and the antenna element in d below.

- (4) For frequencies between 400 and 1,000 mc (tuning unit 4), use Antenna AT-1030/URM-85 (d below).

d. Connect the antenna sections and/or elements to the appropriate balun as indicated in the chart below.

| Tuning unit | Frequency range (mc) | Components required for each side of dipole antenna (fig. 10) | |
|-------------|----------------------|---|--------------------------------------|
| | | AB-21/GR sections | Antenna element required |
| 2 | 20- 31 | 4 | AT-1029/URM-85 |
| 2 | 31- 39 | 3 | AT-1029/URM-85 |
| 2 | 39- 54 | 2 | AT-1029/URM-85 |
| 2 | 54- 70 | 1 | AT-1029/URM-85 |
| 2 | 70- 220 | 0 | AT-1029/URM-85 |
| 3 | 200- 400 | 0 | AT-1028/URM-85 |
| 4 | 400-1,000 | 0 | Integral with Antenna AT-1030/URM-85 |

e. Adjust the length of the dipole antennas as follows:

- (1) Use the megacycle tape (fig. 4) to adjust the length of the appropriate telescopic antenna elements when operating from 20 to 400 mc (the range of tuning units 2 and 3). Measure from the exact center of the balun end which supports the dipoles to the extreme tip of one dipole arm. Repeat the procedure on the other dipole arm.
- (2) Use the megacycle ruler (fig. 4) to adjust the length of the telescopic antenna elements which are permanently secured to the dipole end of Antenna AT-1030/URM-85. For this antenna, measure the length of the dipole by butting the end of the ruler calibrated in megacycles against the tip of the balun. Slide the dipole element to the length that corresponds to the frequency under measurement. Repeat the procedure for the other dipole arm. Turn the ruler over to its reverse side, which shows the proper spacing required between the center of the dipoles and the apex of the corner reflector. Loosen the wingbolt on the clamp and slide the balun back and forth within its mounting to the position that corresponds with the frequency marking on the plastic megacycle. Tighten the wingbolt on the clamp to secure the balun in the proper position.

f. Connect the rf cable between the SIGNAL INPUT receptacle on the main unit

and the antenna; use the red connectors. Set the calibration switch to SERIES CAL & OPERATE and the function switch to CW AVERAGE.

g. When using any of the three dipole antennas, orient the dipole antenna according to the polarization of the transmitting antenna from which a signal is to be received.

- (1) If the transmitting antenna is vertically polarized, loosen the wingbolt on the clamp (note (2) below) that locks the tube of the balun into the desired position and turn the balun so that the dipole is in a vertical position with respect to earth ground. Tighten the wingbolt on the clamp after rotating the balun.
- (2) If the transmitting antenna is horizontally polarized, loosen the wingbolt on the clamp (note below) that locks the bakelite tube of the balun into the desired position and turn the balun so that the dipole is in a horizontal position with respect to earth ground. This position places the dipole broadside to the general direction from which the signal is being received. Tighten the wingbolt on the clamp after rotating the balun.

Note. The wing bolt on the clamp for Couplers, Antenna CU-893/URM-85 and CU-894/URM-85 are shown in figure 4. The clamp (not shown) for Antenna AT-1080/URM-85 is directly behind the corner reflector. When rotating the bakelite tube of the balun for tuning unit 4, both the dipole and the 90° corner reflector will turn

as one unit, because the dipole, balun, and reflector are integral parts of Antenna AT-1030/URM-85 (fig. 1).

h. Observe the pointer deflection on the meter when a signal is being received. If the meter pointer deflects off-scale to the right, set the SIGNAL ATTENUATOR DB control to a higher value until an on-scale reading is obtained. If an on-scale reading cannot be obtained with the SIGNAL ATTENUATOR DB control at 80, insert Attenuator, Fixed CN-721/URM-85 and add 40 db to the signal-level calculation.

i. Use the shunt calibration method (para 18b(1)) if any one of the three dipole antennas is used in the measurement. Use the series calibration method (para 18b(2)) if the loop or vertical antenna is used in the measurements.

j. Perform the procedures in paragraph 20f through h, if applicable.

k. The chart in figure 23 gives the antenna factor to be used in the calculation when the dipole antenna for tuning unit 2, 3, or 4 is used. The chart in figure 24 gives the antenna factor to be used in the calculation when the loop or vertical antenna for tuning unit 1 is used. Refer, to the applicable chart, obtain the db antenna factor for the frequency under measurement, and calculate the signal level in db above 1 uv/meter by adding the following:

Meter reading in db + SIGNAL DB control setting in db + antenna factor (fig. 23 or 24).

Example:

| | |
|---|--------------|
| Meter reading | 15 db |
| SIGNAL ATTENUATOR DB control setting | 20 db |
| Antenna factor | 10 db |
| Total | 45 db |

l. Repeat the procedures in a through k for each frequency to be measured.

23. Broadband, Far-Field Measurements

Measure broadband signals in the far field of the radiating antenna as follows:

a. Start and calibrate the test set (para 19).

b. Set the calibration switch to SERIES

CAL & OPERATE and the function switch to PULSE PEAK.

c. Perform the procedures in paragraph 22b through g; use shunt calibration (para 18b(1)) for the dipole antennas or series calibration (para 18b(2)) for the loop or vertical antenna.

d. Perform the procedures in paragraph 20f through h, if applicable.

e. From the applicable antenna factor chart (fig. 23 or 24), obtain the antenna factor in db for the frequency being measured and calculate the signal level in db above 1 uv/mc/meter by adding the following:

20 db + reading in db+ SIGNAL ATTENUATOR DB control setting in db + antenna factor (fig. 20 or 22).

Example:

| | |
|---|--------------|
| Constant | 20 db |
| Meter reading | 15 db |
| SIGNAL ATTENUATOR DB control setting | 20 db |
| Antenna factor | 10 db |
| Total | 65 db |

Note. The constant 20-db loss is caused by the output signal from the impulse generator being actually 20 db greater than the impulse generator coarse and fine output control markings, when the calibration switch is set to SERIES CAL & OPERATE. In this position of the calibration switch, the output of the impulse generator is directly available at the front panel IMPULSE OUTPUT jack, without being attenuated. The SHUNT CAL position of the calibration switch injects a fixed 20-db attenuator into the signal path of the impulse generator. The calculation is based on using the SERIES CAL & OPERATE position of the calibration switch; therefore, a constant 20-db loss is considered arithmetically.

f. Repeat the procedures in a through e above for each frequency to be measured.

24. Narrow-Band, Near-Field Measurements

Measure narrow-band signals in a near field as follows:

a. Start and calibrate the test set (para 19).

b. Mount the loop, vertical, or discone (broadband) antenna on the tripod. The selection of the proper antenna depends on the tuning unit in use (para 15c).

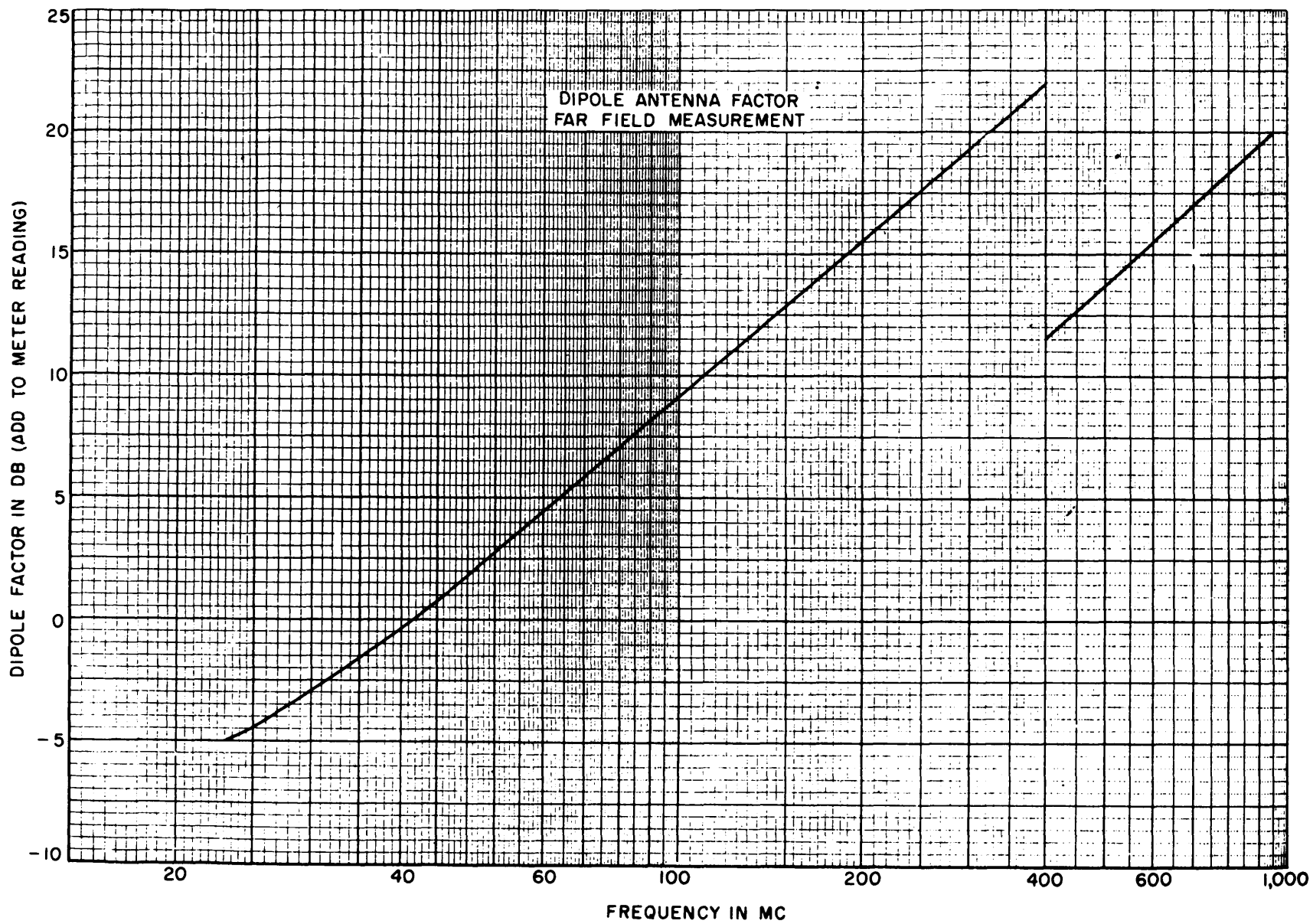

TM6625-351-12-20

Figure 23. Dipole antenna factor chart.

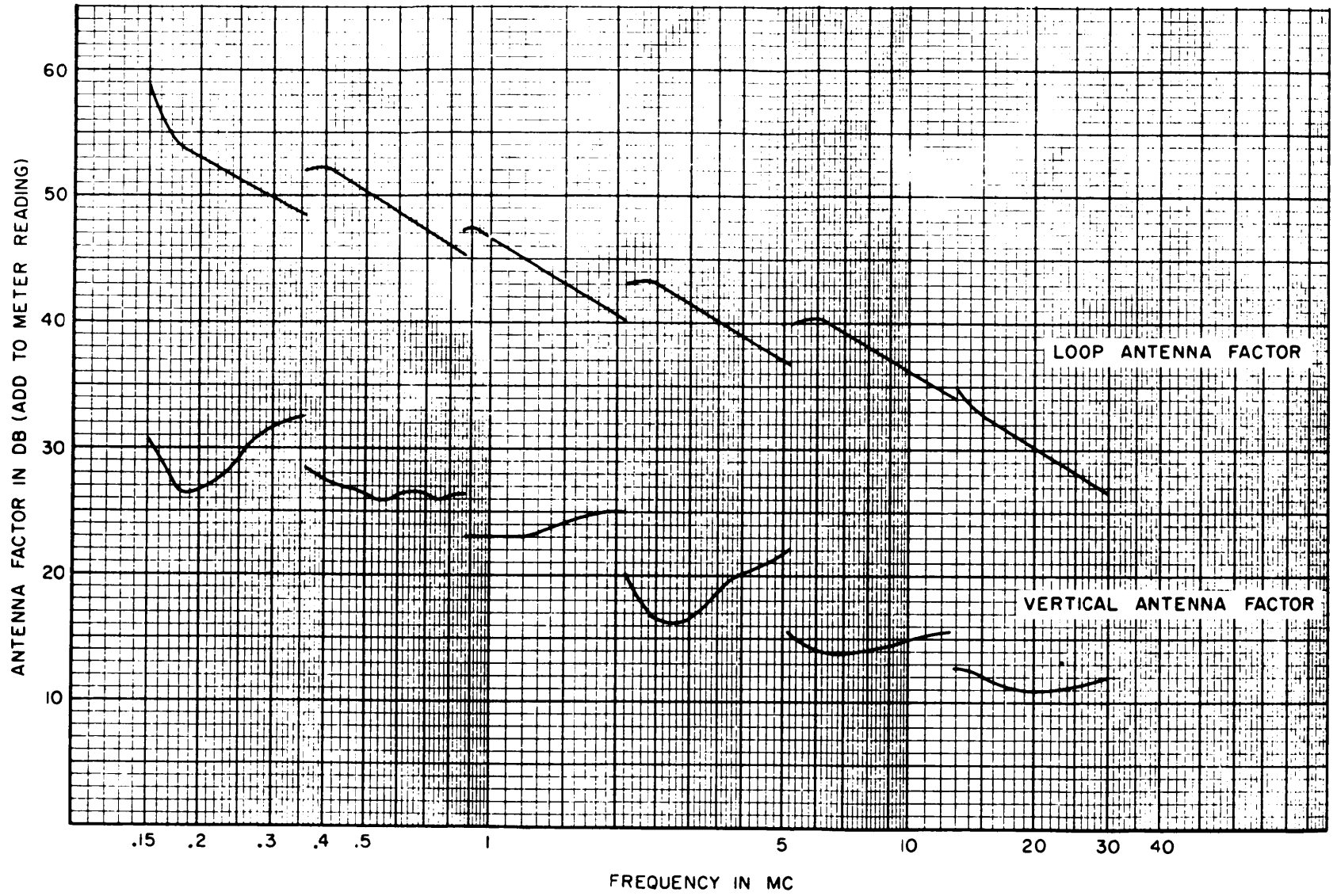

TM6625-351-12-22

Figure 24. Loop and vertical antenna factor chart.

c. Install the required number of Mast Sections AB-21/GR (fig. 5) in the sockets of the discone (broadband) antenna (fig. 25), if used, depending on the frequency under measurement.

d. When the discone (broadband) antenna is used, connect the unbalanced injection block as follows:

(1) Thread the connector (which is not color-coded) on the unbalanced injection block to the terminal at the base of the discone (broadband) antenna.

(2) Thread the red and green connectors, at one end of the rf cable, to the correspondingly color-coded receptacles on the unbalanced injection block.

e. When the loop or vertical antenna is used, mate the red and green receptacles on the antenna base directly to the corresponding color-coded connectors on the rf cable.

f. Connect the other end of the rf cable to the main unit. Mate the rf cable green connector to the IMPULSE OUTPUT receptacle; mate the rf cable red connector to the SIGNAL INPUT receptacle.

g. Set up and orient the antenna in accordance with the applicable test specification. If the specified orientation is not given, orient the antenna to produce a maximum indication on the meter.

h. Set the calibration switch to SERIES CAL & OPERATE and the function switch to C W AVERAGE .

i. Turn on the source of the signal to be measured.

j. Vary the setting of the SIGNAL ATTENUATOR DB control between 0 CW ONLY and 80 for an on-scale reading on the meter. If the meter still deflects off-scale to the right with the SIGNAL ATTENUATOR DB control set at 80, insert Attenuator, Fixed CN-721/URM-85 between the SIGNAL INPUT receptacle and the rf cable, and add 40 db to the calculation (1 below).

k. Perform the procedures in paragraph 20f through h, if applicable.

l. Calculate the antenna open-circuit voltage in db above 1 uv by adding the following:

Meter reading in db + SIGNAL ATTENUATOR DB control setting in db + loss in rf cable (fig. 22).

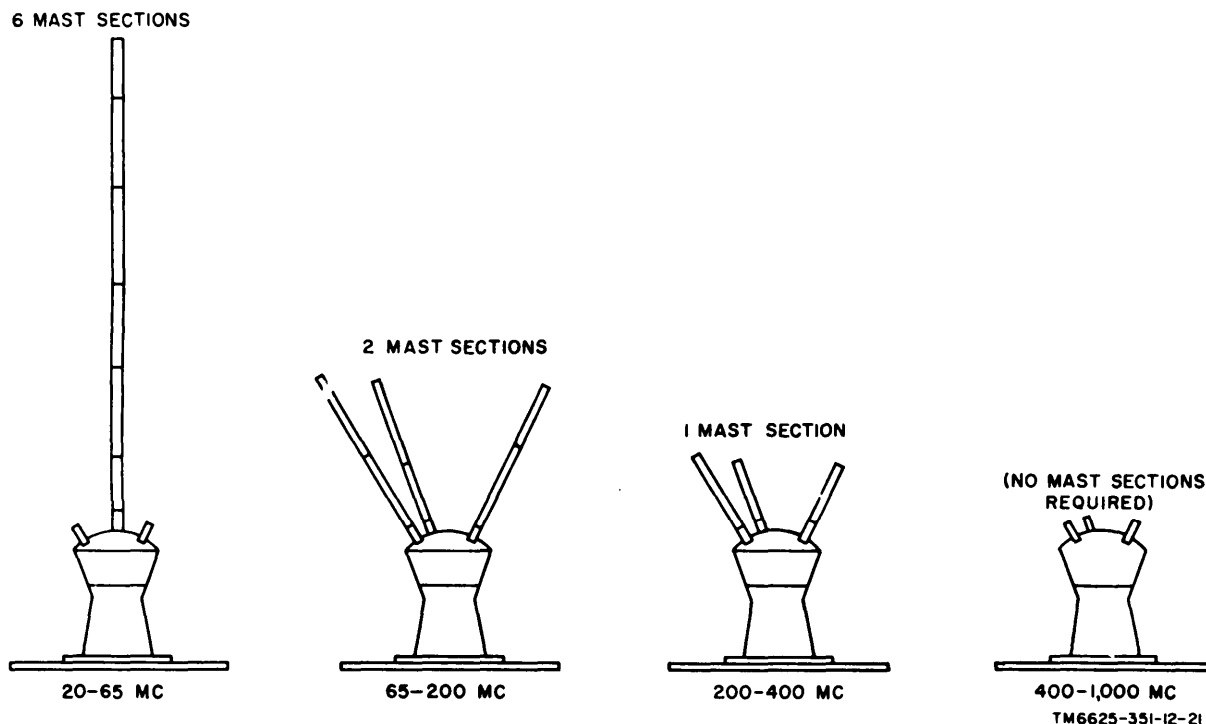

Figure 26. Using Mast Sections AB-21/GR with discone (broadband) antenna.

Example:

| | |
|---|--------------|
| Meter reading | 12 db |
| Rf cable loss (30 ft RG- 5B/U) | 1 db |
| SIGNAL ATTENUATOR DB control setting | 40 db |
| Total . . . | 53 db |

Note. To convert db above 1 microvolt into volts, the following table shows the relationship between the two factors. The voltage corresponding to 53 db in the above example is 144.6 microvolt.

| Decibels above 1 microvolt | Equivalent voltage ratio |
|-------------------------------|--|
| 0 | 1 microvolt |
| 20 | 10 microvolts |
| 40 | 100 microvolts |
| 60 | 1,000 microvolts (or 1 millivolt) |
| 80 | 10,000 microvolts (or 10 millivolts) |
| 100 | 100,000 microvolts (or 100 millivolts) |

m. Repeat the procedures in a through l above for each frequency to be measured.

25. Broadband, Near-Field Measurements

Measure broadband (noise) signals in the near field of a radiating antenna as follows:

a. Start the test set (para 19a).

Note. This procedure employs the substitution method of measurement (para 18c). Do not perform the calibration procedure (para 193(5) through (10)).

b. Mount the loop, vertical, or discone (broadband) antenna on the tripod (para 24b through g).

c. Set the calibration switch to SERIES CAL & OPERATE and the function switch to PULSE PEAK.

d. Set the GAIN control about midposition, and turn on the source of the signal to be measured.

Note. If radio-station interference or other cw interference is present at the frequency under measurement, tune the test set to a slightly different frequency. This procedure will enable the test set to indicate the intensity of the broadband (noise) signal only.

e. Set the SIGNAL ATTENUATOR DB control to a position that gives an on-scale indication on the meter. Do not use the 0 CW ONLY position. If the meter pointer deflects off-scale to the right, insert Attenuator, Fixed CN-721/URM-85 between the rf cable and the SIGNAL INPUT

receptacle and add 40 db to the calculation.

f. Adjust the GAIN control for a 10-db meter indication, and adjust the VOLUME control for a comfortable listening level.

g. Turn off the source of the signal being measured. If the source of the signal (such as a power generator in continuous operation) cannot be turned off, set the impulse generator ON-OFF switch to ON. Adjust the impulse generator fine output control to produce a meter reading 1 db higher than the meter reading produced by the unknown signal. The value of the unknown signal is, therefore, 1 db less than the settings of the impulse generator coarse and fine output controls. Be sure to consider the db loss for the rf cable (fig. 22).

h. If the SIGNAL ATTENUATOR DB control is set at 0 SUBST. ONLY or 20, do not disturb this setting. If it is at 40, 60, or 80, set the control to 20. Add the difference between 20 and the previous setting (40, 60, or 80) into the calculated value, as shown in m below.

i. Set the impulse generator ON-OFF switch to ON.

j. Turn the impulse generator coarse output control until the meter indication is between 0 and 10 db.

k. Turn the impulse generator fine output control for an exact 10-db meter indication.

l. Perform the procedures in paragraph 20f through h if applicable.

m. Calculate the antenna open-circuit voltage produced by the signal being tested in db above 1 uv/mc by adding the following:

Setting of impulse generator output controls + difference found in h above + loss in rf cable (fig. 22).

Example:

| | |
|--|--|
| Impulse generator output control settings | |
| RF cable loss (30 ft RG- 5B/U) | |
| Difference in setting of SIGNAL ATTENUATOR DB control (h above) . . . | |

Note. The difference in the setting of the SIGNAL ATTENUATOR DB control depends on the magnitude of the signal being received. If the level of the signal received requires a SIGNAL ATTENUATOR DB control setting of 60 to obtain an on-scale meter indication, change the example above by adding a difference factor of 40 db. If a still higher level incoming signal is received, the SIGNAL ATTENUATOR DB control may require a setting of 80 to produce an on-scale meter reading; then, change the example above by adding a difference factor of 60 db.

n. Repeat the procedures in d through m above for each frequent *y* to be measured.

26. Measuring More Than One Level of Broadband Signals at One Frequency

Measure more than one broadband signal (at different signal strength levels) at one frequency as follows:

a. Start the test set (para 19a).

b. Mount the loop, vertical or discone (broadband) antenna on the tripod (para 24b through g).

c. Set the calibration switch to SERIES & OPERATE and the function switch to PULSE PEAK.

d. Set the GAIN control at its approximate midposition. Do not set the GAIN control near its minimum gain (extreme counterclockwise) position. Rotating the GAIN control to its minimum setting may result in overloading stages of the intermediate-frequency (if.) amplifier and producing erroneous indications.

Note. If radio-station interference or other cw interference is present at the frequency under measurement, tune the test set to a slightly different frequency. This procedure will enable the test set to indicate the intensity of the broadband (noise) signal only.

e. Be sure the SLIDEBACK control on the tuning unit is fully counterclockwise. Even though this measurement does not use the slideback technique, it is essential that the SLIDEBACK control have no effect on the amplitude of the final audio output from the main unit.

f. Turn on the source of the signals to be measured, and set the SIGNAL ATTENUATOR DB control to produce an approximate midscale deflection of the meter pointer.

g. Use the headset to listen to the audio

output of the signals under "measurement. Vary the setting of the VOLUME control so that the lowest level signal being detected becomes barely audible.

h. Shut off the source of the signal under test.

i. Set the impulse generator ON-OFF switch to ON.

j. Set the impulse generator fine output control to 0.

k. Turn the impulse generator coarse output control clockwise (to higher levels of attenuation), until the noise output from the calibrating signal is heard in the headset. Turn the coarse output control one step (10 db) counterclockwise.

l. Turn the impulse generator fine output control clockwise until the noise output from the calibrating signal again becomes barely audible. Turn the fine output control one step (1 db) counterclockwise.

m. The antenna open-circuit voltage produced by this lowest level signal is shown by the setting of the impulse generator output controls.

n. Repeat the procedures in a through k above for each successively higher signal level, at the same signal frequency.

27. Substitution Method of Measurement Using Aural Slideback Technique

The slideback technique can be used when performing the substitution method of measurement (para 18c). This technique permits discrimination among several types of interference which may be present simultaneously. It also permits evaluation of interference occurring at very low repetition rates, even as low as one cycle per second (cps).

a. Start the test set (para 19a).

Note. This procedure employs the substitution method of operation. Do not perform the calibration procedure (para 19b(5) through (10)).

b. Set the SLIDEBACK and VOLUME controls to midrange.

c. Adjust the GAIN control until a slight hiss is heard in the headset in the absence of any incoming signal. Do not set the GAIN control too near its minimum gain (extreme counterclockwise) position. Rotating the GAIN control to its minimum

setting may result in overloading stages in the if. amplifier and producing erroneous indications.

d. Set the calibration switch to SERIES CAL & OPERATE. Turn the impulse generator ON-OFF switch to OFF and rotate the function switch to PULSE PEAK.

e. Tune the test set to desired operating frequency. Use the headset to listen to the audio output of the broadband signal under measurement. Set the SIGNAL ATTENUATOR DB control to the highest db position which will still permit aural monitoring of the broadband signal under measurement.

f. Adjust the SLIDEBACK control until the audio output is at the point of disappearing. This is the threshold point of audibility.

Note. If a slight hum is heard when monitoring the output, the hum is probably caused by connection to a 400-cycle power source. Reverse the test set power cable connector at the ac output to reduce the hum level.

g. Turn off the source of the noise signal under measurement. Do not disturb the setting of the SLIDEBACK and GAIN controls until the measurement is completed.

h. Set the impulse generator ON-OFF switch to ON. Vary the settings of the impulse generator coarse and fine output controls until the audio signal heard in the headset is at the point of disappearing. The settings of the impulse generator output controls now show the level of the noise signal in db above 1 uv/mc.

28. Substitution Method of Measurement Using Metered Slideback Technique

The metered slideback technique provides a visual reference for aural slideback measurements (para 27). Proceed as follows :

a. Start the test set (para 19a).

Note. This procedure employs the substitution method of operation. Do not perform the calibration procedure (para 19b(5) through (10)).

b. Set the VOLUME control to midposition. Do *not* vary this setting throughout the following procedure.

c. Set the function switch to METERED SLIDEBACK, the SIGNAL ATTENUATOR

D13 control to 20, the calibration switch to SERIES CAL & OPERATE, and the IMPULSE GENERATOR output coarse control to 60 and the fine control to 0.

d. Adjust the SLIDEBACK control to obtain a meter pointer deflection of 0 db.

e. Set the impulse generator ON-OFF switch to ON and slowly turn the GAIN control counterclockwise from its midposition until the audio signal heard in the headset is at the point of disappearing. The meter is now calibrated for 60 db above 1 uv/mc full-scale deflection.

f. Set the impulse generator ON-OFF switch to OFF.

g. Turn on the source of the signal to be measured.

h. Adjust the SLIDEBACK control to obtain the threshold level of audibility (para 27f). Add the meter reading to the setting of the impulse generator output controls (60 db above 1 uv/mc) to obtain the level of the unknown noise in db above 1 uv/mc, as follows:

Meter reading in db + impulse generator output controls setting.

Example:

| | |
|--|--------------|
| Meter reading | 12 db |
| Setting of impulse generator output controls . . . | <u>60 db</u> |
| Total | 72 db |

Note. The meter full-scale range may be extended to 80, 100, or 120 db by changing the setting of the SIGNAL ATTENUATOR DB control to successively higher db positions. Perform this step *only* if the level of the signal under measurement is so high that the meter pointer deflects off-scale to the right when the SIGNAL ATTENUATOR DB control is set tm 20. As an example, if the SIGNAL ATTENUATOR DB control has been set to 40 because of the high intensity of the incoming signal, the calculation must include this factor. Therefore, the information in h above would change as follows:

| | |
|--|--------------|
| Meter reading | 12 db |
| Setting of impulse generator output controls . . . | 60 db |
| Difference between setting of SIGNAL ATTENUATOR DB control and the setting required in c above . . . | <u>20 db</u> |
| Total | 92 db |

29. Localizing Source of Noise Interference

Pinpoint the source of noise interference generated by various types of machinery or electronic equipment as follows:

a. Connect the rf cable between the SIGNAL INPUT receptacle on the main unit and the electric field probe (fig. 5). Mate the red connector at one end of the rf cable to the receptacle at the end of the probe; mate the red connector at the other end of the rf cable to the SIGNAL INPUT receptacle.

b. Tune the test set to the frequency to be checked by using the bandswitch (on tuning units 1, 2, and 4) and the TUNING control.

c. Set the other controls as follows:

| Control | Position |
|---|---|
| SIGNAL ATTENUATOR DB Calibration switch | 0 SUBST. ONLY SERIES CAL & OPERATE |
| Function switch VOLUME control | PULSE PEAK Comfortable listening level |

d. Adjust the GAIN control so that the meter indicates approximately 0 db, with no signal applied to the input of the test set.

e. Turn on the equipment under test, and adjust it for the desired operating conditions.

f. Move the electrical field probe slowly around the equipment under test until a signal is heard in the headset. - Move the probe in the pickup area until maximum signal is heard. The probe is now closest to the source of noise interference and the area should be marked. If the meter reads off-scale to the right, increase the setting of the SIGNAL ATTENUATOR DB control until the meter pointer is approximately at midscale. (This is a reference.)

g. Set the calibration switch to SHUNT CAL and the impulse generator ON-OFF switch to ON. This grounds the incoming signal to the test set, and applies the output of the impulse generator to the meter.

h. Adjust the impulse generator output controls to obtain the reference meter indication (f above). The setting of the im-

pulse generator output controls shows the intensity of the signal, in db above 1 uv/mc.

Note. If the decibel indication just obtained is to be of value, the probe must be placed in a specific spatial relationship with respect to the equipment under measurement.

i. Probe measurements are frequently concerned with relative changes in noise interference produced by noise suppression efforts. Evaluate noise suppression efforts as follows:

- (1) Set the calibration switch to SERIES CAL & OPERATE.
- (2) Set the GAIN control to any convenient reference level, such as a 10-db meter pointer deflection.
- (3) Change the means of suppressing noise in the equipment under measurement.
- (4) Place the probe in the area of noise interference (f above) and observe the new meter pointer deflection. If the meter pointer deflects to a scale marking less than 10 ((2) above), the change made in noise suppression has been effective. If the meter pointer deflects off-scale to the right, the change made in noise suppression has been ineffective. Use other means of suppressing noise in the equipment under "measurement and take further meter readings with the probe.

j. Disconnect the rf cable from the electrical field probe and connect it to Probe, Magnetic Field, Interference Measuring MX-3409/URM-85 or MX-3412/URM-85, depending on the tuning unit used.

k. Repeat the procedures in f through i above. Revolve the loop at one end of the magnetic field probe through 180° to obtain maximum pickup; the magnetic field probe is directional.

l. Repeat the procedures in a through k above for each frequency to be checked.

30. Carrier Field Intensity Measurements Over Frequency Range of Tuning Unit 1

Measure the field intensity of carrier signals over the frequency range of tuning

unit 1 by using the loop antenna rather than the vertical antenna (fig. 3), because the loop antenna is more accurate. Use the vertical antenna only when signal intensity from the loop antenna is too low to produce a meter reading with the SIGNAL ATTENUATOR DB control set at 40. Measure carrier field intensity as follows:

a. Set the bandswitch on tuning unit 1 to the desired range. Be sure to set the bandswitch on the antenna base to the same range.

b. Set other controls as follows:

| Control | Position |
|--|---------------------------------------|
| SIGNAL ATTENUATOR DB Calibration switch | 40 |
| Function switch | SERIES CAL & OPERATE CW AVERAGE |

c. Tune the test set to the frequency of the signal under measurement. No meter pointer deflection is desired at this time, even though the test set must be tuned to a frequency very close to the signal under measurement. Therefore, vary the TUNING control slightly, away from the frequency of the signal under measurement, so that the meter pointer deflects to 0 db.

d. Set the function switch to CW PEAK and the impulse generator ON-OFF switch to ON.

e. Refer to the typical two-terminal voltmeter charts (fig. 16 and 17), and locate the frequency under measurement on the horizontal axis of the chart. Directly above this point on the chart, locate the intersection with the impulse generator setting curve. Proceed horizontally to the left to determine the impulse generator setting in db above 1 uv.

f. Set the impulse generator output controls to the value determined in e above.

g. Adjust the GAIN control to produce a full-scale meter deflection.

h. Set the impulse generator ON-OFF switch to OFF.

i. Set the function switch to CW AVERAGE. The meter is now calibrated to indicate the signal level at the antenna directly in microvolt.

j. Readjust the TUNING control to the exact frequency of the signal under meas-

urement. Tune the test set to produce a maximum meter pointer deflection. Reset the SIGNAL ATTENUATOR DB control, if necessary, to produce an on-scale reading. If the loop antenna is used, rotate it for a maximum meter indication. The vertical antenna need not be rotated on its ground plane since this antenna is omnidirectional.

k. The meter reading, plus the setting of the SIGNAL ATTENUATOR DB control, indicates the level of the signal in db above 1 microvolt at the antenna.

l. To obtain field intensity in db above 1 microvolt/meter, obtain the antenna factor from figure 24. Assume that the frequency under measurement is 1 mc. Figure 19 shows that the impulse generator output controls must then be set to 63 db. With the SIGNAL ATTENUATOR DB control set to 40, the following result will be obtained:

| | |
|---|--------------|
| Meter reading | 15 db |
| SIGNAL ATTENUATOR DB setting | 40 db |
| Total | 55 db |

Note. If the SIGNAL ATTENUATOR DB control has been reset to 60 (for example) to keep the meter pointer on-scale, the final value of the signal under measurement would then be 75 uv/mc.

31. Carrier Field Intensity Measurements Over Frequency Range of Tuning Units 2, 3, and 4

To measure the field intensity of carrier signals over the frequency range of tuning units 2, 3, and 4, use the appropriate dipole antenna (fig. 1 and 4). Proceed as follows:

a. Set the bandswitch on tuning unit 2 or 4 to the range corresponding to the signal frequency under measurement. (Tuning unit 3 covers its entire range in one band.)

b. Calibrate the test set as a two-terminal rf voltmeter (para 19b).

c. Tune in the signal under measurement and set the SIGNAL ATTENUATOR DB control to the position that produces an on-scale meter pointer deflection.

Note. Do not use the 0 SUBST. ONLY position of the SIGNAL ATTENUATOR DB control. This position does not provide the proper impedance match for the balun (fig. 4).

d. Note the meter pointer deflection.

e. Refer to the typical two-terminal voltmeter chart (fig. 20) and locate the frequency under measurement on the horizontal axis of the chart. Directly above this point on the chart, locate the intersection with the impulse generator setting curve. Proceed horizontally to the left to find the impulse generator setting in db above 1 uv.

f. Add the value determined in e above to the meter reading in db and the setting of the SIGNAL ATTENUATOR DB control to obtain the field intensity in db above 1 uv/meter.

Example:

| | |
|-----------------------------------|---------------------|
| Meter reading | 15 db |
| SIGNAL ATTENUATOR | |
| DB setting (assumed | |
| setting of 0 CW ONLY) | 0 db |
| Impulse generator setting | |
| (fig. 20, at an assumed | |
| frequency of 100 mc) . . . | <u>59 db</u> |
| Total | 74 db |

Note. If the SIGNAL ATTENUATOR DB control has been reset to 20 (for example) to keep the meter pointer on-scale, the final value of the signal under measurement would then be 94 db above 1 uv/meter.

32. Stopping Procedure

a. Set the POWER switch on the main unit to OFF.

b. If the external transformer is used, set its power switch to the off (down) position.

CHAPTER 3

MAINTENANCE INSTRUCTIONS

Section I. OPERATOR'S MAINTENANCE

33. Scope of Operator's Maintenance

a. A list of maintenance duties normally performed by the operator of Radio Interference Measuring Set AN/URM-85 is given in b below. The only tools required are those tools normally available to the repairman because of his assigned mission.

b. Operator's maintenance for the test set consists of the following:

- (1) Preventive maintenance (para 34).
- (2) Visual inspection (para 35).
- (3) Use of the operational checklist (para 36).
- (4) Replacement of the specified electron tubes (para 37), the vibrating-type voltage regulator, the pilot lamp on the main unit, and the fuse in the main unit and the external transformer.

34. Operator's Preventive Maintenance

a. DA Form H-266. DA Form 11-266 (fig. 26 and 27) is a preventive maintenance checklist to be used by the operator. Items that are not applicable to the test set are lined out. References in the ITEM block in the figures are to paragraphs that contain additional maintenance information pertinent to the particular item. Instructions for use of the form appear on page 1 of the form.

b. Items. The information below supplements DA Form 11-266. The item numbers correspond to the ITEM numbers on the form.

| Item | Maintenance procedure |
|------|--|
| 1 | Use a clean cloth to remove dust, dirt, moisture, or grease from the main unit, tuning units, external transformer, discone (broadband) antenna, loop antenna, and vertical antennas, baluns, antenna elements, Mast Sections AB-21/GR, probes, conductive |

| Item | Maintenance procedure |
|------|--|
| 3 | couplers, remote meter, tripod, and transit chest and cases. If necessary, clean the outside of the various components of the test set with Cleaning Compound (Federal stock No. 7930-395-9542), and wipe them with a dry, clean cloth. |
| 5 | All control knobs should work smoothly, be tight on the shafts, and should not bind. Tighten all loose knobs and be sure that the knobs do not rub against the panel. Check the spring-return action of the METER DAMP. switch in the spring-loaded MOM. (momentary) position. Pull the SIGNAL ATTENUATOR DB control and shaft out from the front panel; check for detent action when rotating the control to each of the six positions. Be sure that the knob and shaft can be locked in any position by pushing the knob all the way in, as far as possible, toward the front panel. Check the bandswitch knobs on the loop and vertical antenna housings for smooth operation in each of their six positions. Check for looseness of receptacles on minor components, such as the loop, vertical, and discone (broadband) antenna housings, the unbalanced injection block, the two baluns, the balun housing on tuning unit 4 antenna, the fixed 40-db attenuator, the three probes, the external transformer, the four conductive couplers, and the remote meter. |
| 5 | Check for any cuts or breaks in the insulation of the pair of coaxial conductors in the rf cable, or in the remote meter cord, the ac power cable, the test harness, both the short and long headset cords, and the ac power cable at the rear of the external transformer. Be sure to check the wire, which runs from the alligator grounding clip to the two-prong male connector on the ac power cable, for secure mechanical contact. |
| 6 | Check to see that the zipper fastener on the tripod bag is in good condition, by opening and closing the zipper around the complete circumference of the bag. Also check to see that there is no break in the lining at the bottom of the bag. |
| 7 | Check to see that the handles at the left side of the tuning unit front panel and at the bottom center of the main unit have good spring tension. Do not use excessive force on the tuning unit handle; doing so will result in withdrawing the tuning unit from its compartment in the main unit. |
| 10 | Inspect the main unit, front panels of the tuning units, loop antenna, discone (broadband) antenna, base of the vertical antenna, ground plane, and external transformer for rust and corrosion. |

| Item | Maintenance procedure |
|------|---|
| 11 | Be sure to check both the meter mounted on the front panel of the main unit and the remote meter for damaged glass and housings. |

Warning: Cleaning compound is flammable and its fumes are toxic. Do not use it near a flame; provide adequate ventilation.

35. Operator's Visual Inspection

a. Visual inspection will often determine the general condition of the equipment and the amount of repair required. When the equipment fails to perform properly, turn off the power and check the items listed below. *Do not check item with the power on.*

- (1) Wrong settings of switches and controls (para 19 through 31).
- (2) Disconnected, improperly connected, or incorrectly connected ac power cable, long and short headset cords, remote meter cord, rf cable, or power cable assembly at rear of external transformer (if used) (para 15c).
- (3) Broken antenna element, discone (broadband) antenna, loop antenna, vertical antenna base, Mast Section AB-21/GR, balun, unbalanced injection block, magnetic field probe, electric field probe, or conductive coupler.
- (4) When using the discone (broadband) antenna (fig. 4), check to see that the noncolor-coded connector has been threaded tightly to the mating terminal at the base of the discone. Also check to see that the required number of mast sections are employed (fig. 25) for the particular frequency range of the signals under measurement.
- (5) When using the balun for tuning unit 3, check to see that Antenna Elements AT-1028/URM-85 have been threaded securely to the mating inserts at the antenna end of Coupler, Antenna CU-894/URM-85 (fig. 4).
- (6) When using the balun for tuning unit 2, check to see that the re-

quired number of Mast Sections AB-21/GR (para 22d) are threaded into the projecting ferrules on Antenna Coupler CU-893/URM-85, when covering the 20-mc to 70-mc (low-band) frequency range. Check to be sure that one Antenna Element AT-1029/URM-85 terminates each arm of the dipole, after the last mast section. Be sure to use the megacycle tape (fig. 4) to extend the collapsible Antenna Element AT-1029/URM-85 to the resonant length for the particular frequency under measurement.

- (7) When using the balun for tuning unit 2 over the 70-mc to 220-mc (high-band) frequency range, remember that no Mast Sections AB-21/GR are required. Figure 4 shows Antenna Elements AT-1029/URM-85 threaded into each side of Antenna Coupler CU-893/URM-85 as if this frequency range were to be measured. Check with the megacycle tape to see that the antenna elements are set to the proper length for resonating with the particular frequency under measurement.
- (8) When using the vertical antenna (fig. 10), check to be sure that the six series-connected Mast Sections AB-21/GR are inserted into socket at the top of Antenna Coupler CU-890/URM-85. Also be sure that the bandswitch of the base of the vertical antenna is at the same setting as the bandswitch on the front panel of tuning unit 1. Be sure that the vertical antenna has been securely mounted to the ground plane (fig. 4), and that the ground plane is properly locked into position on the tripod.
- (9) When using the loop antenna, check to see that its bandswitch is at the same setting as the bandswitch on the front panel of tuning unit 1. Also check that the color-coded connectors on the rf cable mate with the corresponding color-coding of the receptacles on the loop housing.

| MAINTENANCE CHECK LIST FOR SIGNAL EQUIPMENT TEST EQUIPMENT (AR 750-625) | | | |
|--|------------------------------|-----------------|-----------------------|
| EQUIPMENT NOMENCLATURE <i>RADIO INTERFERENCE MEASURING SET AN/URM-95</i> | | | |
| EQUIPMENT SERIAL NUMBER <i>59</i> | | | |
| INSTRUCTIONS | | | |
| This form may be used for a period of one month by using the correct dates and weeks of the month. It is to be used as a Preventive Maintenance check list for Signal equipment in actual use, or for a check on equipment prior to issue. | | | |
| 1. For detailed Preventive Maintenance instructions see: <ol style="list-style-type: none"> a. The Technical Manual (in TM 11 series) for the equipment. (See DA Pamphlet Number 310-4) b. The Supply Bulletin (SB 11-100 series) for the equipment. (See DA Pamphlet Number 310-4) c. The Department of the Army Lubrication Order. (See DA Pamphlet Number 310-4) | | | |
| 2. The following action will be taken by either the Communications Officer/Chief for 1st echelon, or the Inspector for higher echelon: <ol style="list-style-type: none"> a. Enter Equipment Nomenclature and Serial Number. b. Strike out items that do not apply to the equipment. | | | |
| 3. Operator/Inspector will enter in the columns entitled CONDITION, on the proper line, a notation regarding the condition, using symbols specified under LEGEND. | | | |
| 4. After operator completes each daily inspection he will initial over the appropriate dates under "Daily Condition for Month", then return form to his supervisor. | | | |
| TYPE OF INSPECTION <i>OPERATOR</i> | | | |
| OPER- ATOR | 3-1-50- 5-0-0 | DATE | SIGNATURE |
| <i>✓</i> | | <i>5 MAR 61</i> | <i>Harold Andrews</i> |
| | | | |
| | | | |
| | | | |
| | | | |
| | | | |

FOLD

DA FORM 11-266
MAY 57

Figure 26. DA Form 11-266, pages 1 and 4 (operator).

| LEGEND for marking conditions: Satisfactory, ✓ Adjustment, Repair or Replacement required, X Defect corrected, (X) | | | | | | DAILY CONDITION FOR MONTH OF MARCH 1961 | | | | | | | | | | | | | | | | | | | | | | | | | | | | | |
|---|---|---------------------|---|---|---|---|----------------------------|---|---|---|----|----|----|----|----|----|----|----|----------------------------|----|----|----|----|----|----|----|----|----|----|----|----|----|---|---|--|
| NO. | DAILY ITEM | | | | | | | | | | | | | | | | | | 30- 30- 30- ECLON | | | | | | | | | | | | | | | | |
| | | 1 | 2 | 3 | 4 | 5 | 6 | 7 | 8 | 9 | 10 | 11 | 12 | 13 | 14 | 15 | 16 | 17 | 18 | 19 | 20 | 21 | 22 | 23 | 24 | 25 | 26 | 27 | 28 | 29 | 30 | 31 | | | |
| | 1. CLEAN DIRT AND MOISTURE FROM EXPOSED SURFACES OF HOUSINGS, CASES, CABINETS, CONTROL PANELS, INTER-CONNECTING PLUGS, CABLES, HEADSETS, METER WINDOWS, ETC. PARA. 34b | ✓ | ✓ | ✓ | ✓ | ✓ | ✓ | ✓ | ✓ | ✓ | ✓ | ✓ | ✓ | ✓ | ✓ | ✓ | ✓ | ✓ | ✓ | ✓ | ✓ | ✓ | ✓ | ✓ | ✓ | ✓ | ✓ | ✓ | ✓ | ✓ | ✓ | ✓ | ✓ | ✓ | |
| | 2. INSPECT FOR LOOSENESS OF EXTERIOR ITEMS SUCH AS SWITCHES, KNOBS, JACKS, CONNECTORS AND PILOT LIGHTS. PARA. 34b | ✓ | ✓ | ✓ | ✓ | ✓ | ✓ | ✓ | ✓ | ✓ | ✓ | ✓ | ✓ | ✓ | ✓ | ✓ | ✓ | ✓ | ✓ | ✓ | ✓ | ✓ | ✓ | ✓ | ✓ | ✓ | ✓ | ✓ | ✓ | ✓ | ✓ | ✓ | ✓ | ✓ | |
| | 3. INSPECT CONTROLS FOR BINDING, SCRAPING. TAP CONTROLS LIGHTLY FOR CUT-OUT DUE TO LOOSE CONTACTS. PARA. 34b | ✓ | ✓ | ✓ | ✓ | ✓ | ✓ | ✓ | ✓ | ✓ | ✓ | ✓ | ✓ | ✓ | ✓ | ✓ | ✓ | ✓ | ✓ | ✓ | ✓ | ✓ | ✓ | ✓ | ✓ | ✓ | ✓ | ✓ | ✓ | ✓ | ✓ | ✓ | ✓ | ✓ | |
| | 4. DURING OPERATION BE ALERT FOR ANY UNUSUAL PERFORMANCE OR CONDITION. PARA. 34b | ✓ | ✓ | ✓ | ✓ | ✓ | ✓ | ✓ | ✓ | ✓ | ✓ | ✓ | ✓ | ✓ | ✓ | ✓ | ✓ | ✓ | ✓ | ✓ | ✓ | ✓ | ✓ | ✓ | ✓ | ✓ | ✓ | ✓ | ✓ | ✓ | ✓ | ✓ | ✓ | ✓ | |
| WEEKLY | | CONDITION EACH WEEK | | | | | 30- 30- 30- ECLON | ADDITIONAL ITEMS FOR 2D AND 3D ECHELON INSPECTIONS | | | | | | | | | | | CONDITION | | | | | | | | | | | | | | | | |
| | 5. INSPECT CORDS, CABLES, WIRE AND SHOCK MOUNTS FOR BREAKS, CUTS, KINKS, DETE-RIORATION, STRAIN AND FRAYING. PARA. 34b | ✓ | | | | | | 18. INSPECT RESISTORS, BUSHINGS, INSULATORS FOR CRACKS, CHIPPING, BLISTERING, DISCOLORATION AND MOISTURE | | | | | | | | | | | | | | | | | | | | | | | | | | | |
| | 6. INSPECT CANVAS AND LEATHER ITEMS FOR FUNGUS, FRAYING, TEARS, BROKEN ZIPPERS AND SNAP FASTENERS. PARA. 34b | ✓ | | | | | | 16. INSPECT JACKS AND CONNECTORS FOR SHOE FIT AND GOOD CONTACTS | | | | | | | | | | | | | | | | | | | | | | | | | | | |
| | 7. HAND CHECK FOR LOOSENESS OF EXTERIOR ITEMS SUCH AS HANDLES, LATCHES, WINDS. PARA. 34b | ✓ | | | | | | 17. INSPECT VARIABLE CAPACITORS FOR DIRT AND MOISTURE | | | | | | | | | | | | | | | | | | | | | | | | | | | |
| | 8. INSPECT FOR LUBRICATION IN ACCORDANCE WITH APPLICABLE MAINTENANCE ORDER. | | | | | | | 18. INSPECT AIR FILTERS FOR CLEANLINESS | | | | | | | | | | | | | | | | | | | | | | | | | | | |
| | 9. INSPECT DRY BATTERIES FOR DIRTY, LOOSE TERMINALS AND LEAKAGE. | | | | | | | 19. INSPECT SCREW-TYPE TERMINALS OF TRANSFORMERS, FIXED CAPACITORS, RESISTORS, CHOKES, POTENTIOMETERS AND RHEOSTATS FOR CORROSION, DIRT AND LOOSE CONTACTS | | | | | | | | | | | | | | | | | | | | | | | | | | | |
| | 10. INSPECT EXPOSED METAL SURFACES FOR RUST AND CORROSION. PARA. 34b | ✓ | | | | | | 20. CLEAN AND TIGHTEN SWITCHES, BLOWERS, RELAY CASES, CLEAN INTERIOR OF CHASSIS AND CABINETS | | | | | | | | | | | | | | | | | | | | | | | | | | | |
| | 11. INSPECT METERS FOR DAMAGED GLASS AND CASES. PARA. 34b | X | | | | | | 21. INSPECT GENERATORS, MOTORS AND DYNAMOTORS FOR BRUSH WEAR, SPRING TENSION, ARCING AND COMMUTATOR WEAR | | | | | | | | | | | | | | | | | | | | | | | | | | | |
| ADDITIONAL ITEMS FOR 2D AND 3D ECHELON INSPECTIONS | | | | | | | CONDITION | 22. INSPECT TERMINAL BLOCKS FOR LOOSE CONNECTIONS, CRACKS AND BREAKS | | | | | | | | | | | | | | | | | | | | | | | | | | | |
| | 12. INSPECT SEATING OF READILY ACCESSIBLE ITEMS OF A PLUCK-OUT NATURE: CRYSTALS, FUSES, CONNECTORS, PLUG-IN COILS, LAMPS, ETC. DO NOT REMOVE ROCK OR TWIST TO INSPECT. USE ONLY A DIRECT PRESSURE TO INSURE THE ITEM IS FULLY SEATED. | | | | | | | 23. INSPECT GASKETS AND BUSHINGS FOR WEAR AND DAMAGE | | | | | | | | | | | | | | | | | | | | | | | | | | | |
| | 13. INSPECT FOR CLEANLINESS AND TIGHTNESS OF SUCH ITEMS AS SHOCK MOUNTS, ANTENNA, ANTENNA MOUNTS AND WAVE GUIDES. | | | | | | | 24. INSPECT CATHODE RAY TUBES FOR BURNED SCREEN SPOTS | | | | | | | | | | | | | | | | | | | | | | | | | | | |
| | 14. INSPECT RELAY AND CIRCUIT BREAKER ASSEMBLIES FOR DIRT, CORROSION, WORN OR BURNED CONTACTS. | | | | | | | 25. BEFORE STORING OR SHIPPING REMOVE ALL BATTERIES | | | | | | | | | | | | | | | | | | | | | | | | | | | |
| | | | | | | | | IF DEFICIENCIES NOTED ARE NOT CORRECTED DURING THE INSPECTION, INDICATE ACTION TAKEN FOR CORRECTION. (Continue on page 4, if more space is needed) | | | | | | | | | | | | | | | | | | | | | | | | | | | |
| | | | | | | | | ITEM 11. BROKEN GLASS ON MAIN UNIT METER. TURNED EQUIPMENT IN FOR HIGHER ECHELON REPAIR. | | | | | | | | | | | | | | | | | | | | | | | | | | | |

Note. The discone (broadband), loop, and the vertical antennas are the only signal pickup devices that require the use of both the red and the green color-coded connectors at each end of the taped pair of Cable Assembly Set, Electrical MX-3410/URM-85 (fig. 5). Use only the red color-coded connectors with all other signal pickup devices.

(10) When using the remote meter (fig. 1), be sure that one end of the remote meter cord is securely plugged into the jack on the side of the remote meter housing. Check the other end of this cord for secure mating with the RECORDER EXT METER jack on the main unit front panel.

b. If the above checks do not locate the trouble, proceed to the operational checklist (para 36).

36. Operational Checklist

a. General. This checklist outlines a procedure for systematically checking equipment operation. All corrective measures that can be performed by the operator are given in the *Corrective measures* column. If the corrective measures do not restore normal equipment operation, troubleshooting is required by higher echelon maintenance personnel. Note on the repair tag the corrective measures that were taken and how the equipment performed at the time of failure.

b. Procedure. Operate the test set as described in c below, in the order given. Observe equipment operation and perform the corrective measures indicated.

Warning: Before removing electron tube V702, V703, V708, or V709, disconnect the main unit from the ac power source and refer to paragraph 37.

| Step | Unit | Action or condition | Normal indication | Corrective measures |
|------|---|--|-------------------|---------------------|
| 1 | Main unit. | Set POWER switch to OFF | None. | |
| 2 | External transformer. | Set power switch off (down) | None. | |
| 3 | External transformer (for operation from 120-volt or 240 volt, 50- to 400-cps power-lines). | Plug main unit ac power cable into AC OUTPUT receptacle on external transformer (fig. 13); plug other end of cable into POWER receptacle on main unit panel. Set transformer 120V-240V switch as applicable (depending on power source voltage), and plug transformer power connector, at end of integral power cable, into ac outlet. | None. | |
| 4 | Ac power cable without use of external transformer. | For 120-volt, 50-60-cycle ac operation, where isolation from the power source is not desired, connect ac power cable directly between power source and POWER receptacle on main unit front panel. | None. | |
| 5 | Tuning unit 2. | Plug into main unit (para 14c). Set bandswitch to 20-70. | None. | |
| 6 | Balun for tuning unit 2. | Mount on tripod | None. | |
| 7 | Rf cable. | Connect between SIGNAL INPUT receptacle on main unit and N-type receptacle on balun for tuning unit 2. Use only red color-coded connector on rf cable. | None. | |
| 8 | Main unit. | Set function switch to PULSE PEAK (fig. 11). | None. | |

| Step | Unit | Action or condition | Normal indication | Corrective measures |
|------|---------------------------------|--|--|---|
| 10 | Main unit. | Set impulse generator ON-OFF switch to ON. | None. | |
| 11 | Main unit. | Set impulse generator coarse output control to 70; fine output control to 10 (fig. 11). | None. | |
| 12 | Main unit. | Set METER DAMP. switch to OFF. | None. | |
| 13 | Main unit. | Set VOLUME control to mid-position. | None. | |
| 14 | Main unit. | Set SIGNAL ATTENUATOR DB control to 20. | None. | |
| 15 | Headset. | Plug one headset into either PHONES jack on main unit; use short headset cord. Plug the other headset into remaining PHONES jack on main unit; use second short headset cord in series with long headset cord. | None. | |
| 16 | Remote meter. | Connect to RECORDER EXT METER jack on main unit; use remote meter cord. | None. | |
| 17 | Main unit. | Set calibration switch to SHUNT CAL. | | |
| 18 | External transformer (if used). | Set power switch to ON (fig. 13). | None. | |
| 19 | Main unit and tuning unit 2. | Set POWER switch to ON | Pilot lamp on main unit and dial lamp on tuning unit become illuminated. | Check only main unit pilot lamp and replace, if necessary; access to pilot lamp is obtained by removal of indicator light lens from front panel. If dial lamp on tuning unit does not light, higher echelon repair is required. Inspect fuses in external transformer (if used) and main unit; replace, if necessary. Tuning unit not seated firmly in main unit compartment. Push tuning unit all the way in. Higher echelon repair required. |
| 20 | Main unit. | Set function switch to ZERO ADJ. Rotate ZERO ADJ. control to obtain a 0-db indication on both meters. | Meter indicates activity, showing that impulse generator signal is being coupled, through tuning unit, to meter circuit. Meters can be adjusted to 0 db (on upper scale of meters). | If main unit panel meter is operative but remote meter is not, check connections of external meter cord. Higher echelon repair required. Replace electron tubes V702 and V703 in main unit (para 37). Replace V708 and V709. Higher echelon repair required. |

| Step | Unit | Action or condition | Normal indication | Corrective measures |
|------|----------------|--|---|---|
| 21 | Main unit. | Reset function switch to PULSE PEAK. | Noise heard in both headsets. <i>Note.</i> When it is established that both headsets and three headset cords are not defective, disconnect short and long headset cords (connected in series) and use only one headset for the rest of checks. | Higher echelon repair required. |
| 22 | Main unit. | Decrease impulse generator coarse and fine output control settings. | Meters indicate noise level. Noise decreases in headset and meter reading decreases. | Higher echelon repair required. Higher echelon repair required. |
| 23 | Main unit. | Increase impulse generator coarse and fine controls to their previous settings of 70 and 10, respectively. | Noise increases in headset and meter reading increases. | Higher echelon repair required. |
| 24 | Main unit. | Rotate SIGNAL ATTENUATOR DB control successively from 20 to 0 SUBST. ONLY, 40, 60, and then to 80 (para 16a). Reset SIGNAL ATTENUATOR DB control to 20, after checking the five listed switch positions. Throughout following steps, maintain an on-scale meter pointer deflection by rotating SIGNAL ATTENUATOR DB control to higher settings (40, 60, or 80) as necessary. If intensity of incoming signal is so high that meter pointer deflects off-scale to right at a control setting of 80, insert 40-db Attenuator, Fixed CN-721/URM-85 between the SIGNAL INPUT receptacle and red color-coded connector on rf cable. | Meter reading and noise signal in headset changes at each setting. Meter reading is maintained on-scale. | Higher echelon repair required. Higher echelon repair required. |
| 25 | Main unit. | Set impulse generator ON-OFF switch to OFF; calibration switch to SERIES CAL & OPERATE; and function switch to ZERO ADJ. | Meter indicates 0 db. | Rotate ZERO ADJ. control to reset meter pointer to 0 db. |
| 26 | Main unit. | Set function switch to CW AVERAGE | Meter reading changes changes if rf signal is present. | Perform step 27. |
| 27 | Tuning unit 2. | Rotate TUNING control to tune in a narrow-band (modulated cw) signal, known to be operating at a particular frequency within range from 20 to 70 mc. | Signal is heard in headset. | Check antenna sections (if applicable) for resonant length (para 22d). Check rf cable connections. Higher echelon repair required. |
| 28 | Main unit. | Rotate GAIN control clockwise and counterclockwise. Rotate VOLUME control clockwise and counterclockwise. Set volume control for comfortable listening level. | Meters indicate activity. Noise level changes in headset. Noise level increases and then decreases in headset. | Higher echelon repair required. Higher echelon repair required. Higher echelon repair required. |
| 29 | Main unit. | Set function switch to CW PEAK. | Meter reading changes with respect to step 27. | Perform step 28. |

| Step | Unit | Action or condition | Normal indication | Corrective measures |
|------|------------------------------|---|---|---------------------------------|
| 30 | Tuning unit 2. | Keep TUNING control tuned to modulated cw signal (step 27). | Signal is heard in headset; meter now indicates peak envelope voltage of modulated signal. | Higher echelon repair required. |
| 31 | Main unit. | Set function switch to METERED SLIDEBACK. Rotate SLIDEBACK control to approximate midposition; then turn control slowly counterclockwise so that signal heard in headset is at threshold of audibility. | Signal heard in headset decreases in volume. Meter indicates more accurate peak envelope voltage of signal than in step 30. | Higher echelon repair required. |
| 32 | Main unit. | Set SIGNAL ATTENUATOR DB control to 0 CW ONLY. Set function switch to CW AVERAGE. | See step 33. | |
| 33 | Tuning unit 2. | Rotate TUNING control to tune in a low-amplitude rf cw signal, over frequency range of 20 to 70 mc. | Meter reading changes with respect to indication observed in step 31. If meter pointer fluctuations due to transients are noticed, perform step 34. | Higher echelon repair required. |
| 34 | Main unit. | Set METER DAMP. switch to ON or MOM. (if meter pointer fluctuates in step 33.) | Meter pointer stops fluctuating in presence of intermittent transients. | Higher echelon repair required. |
| 35 | Main unit. | Set METER DAMP. switch to OFF. | None. | |
| 36 | Tuning unit 2. | Set bandswitch to 70-220. Repeat steps 10, 17, and 20 through 31, except tune in a modulated cw signal known to be operating at a particular frequency within range from 70 to 220 mc. | Same as steps 20 through 31. | Same as steps 20 through 31. |
| 37 | Main unit. | Set POWER switch to OFF..... | Pilot lamp and tuning unit dial lamp become extinguished. | Higher echelon repair required. |
| 38 | Tuning unit 2. | Remove tuning unit from main unit (para 14c). | None. | |
| 39 | Tuning unit 3. | Plug into main unit (para 14c).. | None. | |
| 40 | Balun for tuning unit 2. | Remove from tripod | None. | |
| 41 | Balun for tuning unit 3. | Mount on tripod | None. | |
| 42 | Main unit and tuning unit 3. | Set POWER switch to ON. | Pilot lamp on main unit and dial lamp on tuning unit become illuminated. | Same as step 19. |
| 43 | Rf cable. | Disconnect rf cable from balun for tuning unit 2; connect rf cable to N-type receptacle on balun for tuning unit 3. Repeat steps 10, 17, and 20 through 31, except tune in a modulated cw signal known to be operating at a particular frequency within range from 200 to 400 mc. | Same as steps 20 through 31. | Same as steps 20 through 31. |

| Step | Unit | Action or condition | Normal indication | Corrective measures |
|------|---|--|---|---------------------------------|
| 44 | Main unit. | Set POWER switch to OFF | Pilot lamp and tuning unit dial lamp become extinguished. | Higher echelon repair required. |
| 45 | Tuning unit 3. | Remove tuning unit from main unit (para 14c). | None. | |
| 46 | Tuning unit 4. | Plug into main unit (para 14c). Set bandswitch to 400-700. | None. | |
| 47 | Balun for tuning unit 3. | Remove from tripod | None. | |
| 48 | Dipole antenna and reflector for tuning 4. | Assemble and mount on tripod. | None. | |
| 49 | Main unit. | Set POWER to ON | Pilot lamp on main unit and dial lamp on tuning unit become illuminated. | Same as step 19. |
| 50 | Rf cable. | Disconnect rf cable from balun for tuning unit 3, and connect rf cable to N-type receptacle on dipole antenna and reflector for tuning unit 4. Repeat steps 10, 17, and 20 through 31, except tune in a modulated cw signal known to be operating at a particular frequency within range from 400 to 700 mc. | Same as steps 20 through 31. | Same as steps 20 through 31. |
| 51 | Tuning unit 4. | Set bandswitch to 700-1000. Repeat steps 10, 17, and 20 through 31, except tune in a modulated cw signal known to be operating at a particular frequency within range from 700 to 1,000 mc. | Same as steps 20 through 31. | Same as steps 20 through 31. |
| 52 | Rf cable. | Disconnect rf cable from dipole antenna and reflector for tuning unit 4. | None. | |
| 53 | Dipole antenna and reflector for tuning unit 4. | Remove from tripod | None. | |
| 54 | Discone (broadband) antenna. | Attach to ground plane and mount both items on tripod. | None. | |
| 55 | Unbalanced injection. | Mate noncolor-coded connector on unbalanced injection block to terminal at base of discone (broadband) antenna. | None. | |
| 56 | Rf cable. | Connect both red and green color-coded connectors of rf cable to corresponding connectors on unbalanced injection block. Be sure to mate green color-coded connector at receiver end of rf cable to IMPULSE OUTPUT receptacle on main unit. | None. | Check cable connections. |
| 57 | Tuning unit 4. | Repeat step 51 but use discone (broadband) antenna. | Same as step 51. | Same as step 51. |
| 58 | Main unit. | Set POWER switch to OFF. | Pilot lamp on main unit and dial lamp on tuning unit become extinguished. | Higher echelon repair required. |
| 59 | Tuning unit 4. | Remove tuning unit from main unit (para 14c). | None. | |
| 60 | Tuning unit 1. | Plug into main unit (para 14c). Set bandswitch to .15-.36. | None. | |

| Step | Unit | Action or condition | Normal indication | Corrective measures |
|------|---|--|--|------------------------------|
| 61 | Rf cable. | Disconnect from unbalanced injection block. | None. | |
| 62 | Unbalanced injection block. | Remove from discone (broad-band) antenna. | None. | |
| 63 | Vertical antenna base. | Mount on tripod. | None. | |
| 64 | Rf cable. | Connect to similarly color-coded receptacles on base of vertical antenna. | None. | |
| 65 | Mast Section AB-21/GR. | Connect six sections to socket at top of vertical antenna base (fig. 10). | None. | |
| 66 | Main unit. | Set POWER switch to ON. | Pilot lamp on main unit and one of the dial lamps on tuning unit become illuminated. | Same as step 19. |
| 67 | Vertical antenna. | Turn bandswitch to .15- .36. Repeat steps 10, 17, and 20 through 31, except tune in a modulated cw signal known to be operating at a particular frequency within the range from 150 kc to 360 kc. | Same as steps 20 through 31. | Same as steps 20 through 31. |
| 68 | Tuning unit 1 and vertical antenna. | Repeat step 67, except rotate bandswitch on both tuning unit and vertical antenna base, successively, to the five remaining positions. In each position, tune in a modulated cw signal known to be operating at a particular frequency within range of each band. | Same as step 67. | Same as step 67. |
| 69 | Vertical antenna. | Disconnect both lengths of rf cable from base of vertical antenna. Remove vertical antenna and ground plane from tripod. | None. | |
| 70 | Loop antenna. | Mount loop antenna on tripod. | None. | |
| 71 | Rf cable. | Connect green and red color-coded connectors to receptacles on base of loop antenna. | None. | |
| 72 | Loop antenna. | Rotate loop on its swivel joint to obtain maximum pointer deflection on main unit and remote meters. Repeat steps 67 and 68. | Same as steps 20 through 31. | Same as steps 20 through 31. |
| 73 | Rf cable and both 50-ohm conductive couplers. | Disconnect rf cable from loop antenna; connect red color-coded connector only to N-type receptacle on 50-ohm conductive coupler. Connect coupler to two-wire power or audio-signal line of approximately 50 ohms impedance, on which modulated cw signals at frequencies of tuning unit used are known to be present. Repeat steps 10, 17, and 20 through 31, successively, using tuning unit 1, and either tuning unit 2, 3, or 4. Be sure to | Same as steps 20 through 31. | Same as steps 20 through 31. |

| Step | Unit | Action or condition | Normal indication | Corrective measures |
|------|--|---|---|---------------------------------|
| 74 | Rf cable and both 500-ohm conductive couplers. | <p>use Coupler, Radio Frequency Interference CU-891/URM-85 when operating with tuning unit 1, and Coupler, Radio Frequency Interference CU-896/URM-85 when operating with tuning unit 2, 3, or 4.</p> <p>Disconnect rf cable from 50-ohm conductive coupler and connect to N-type receptacle on 500-ohm conductive coupler. Connect coupler to two-wire power on audio-signal line of approximately 500 ohms impedance, on which modulated cw signals at the frequencies of tuning unit are known to be present. Repeat steps 10, 17, and 20 through 31, successively, using tuning unit 1, and either tuning unit 2, 3, or 4. Be sure to use Coupler Radio Frequency Interference CU-892/URM-85 when operating with tuning unit 1, and Coupler, Radio Frequency Interference CU-897/URM-85 when operating with tuning unit 2, 3, or 4.</p> | Same as steps 20 through 31. | Same as steps 20 through 31. |
| 75 | Rf cable and magnetic field probes. | <p>Disconnect rf cable from 500-ohm conductive coupler and connect it to one of magnetic field probes, depending on tuning unit used. Use Probe, Magnetic Field, Interference Measuring MX-3409/URM-85 when operating with tuning unit 1, and Probe, Magnetic Field, Interference Measuring MX-3412/URM-85 when operating with tuning unit 2, 3, or 4.</p> | Noise heard in headset, and meter pointer deflects to indicate relative signal intensity. | Higher echelon repair required. |
| 76 | Main unit. | Set function switch to PULSE PEAK, and SIGNAL ATTENUATOR DB control to 0 SUBST. ONLY. | None. | |
| 77 | Magnetic field probe. | Move magnetic field probe in vicinity of source of rf interference; use that tuning unit which corresponds to frequency of loop through 180° for maximum meter indication. | Noise heard in headset, and meter pointer deflects to indicate relative signal intensity. | Higher echelon repair required. |
| 78 | Rf cable and electric field probe. | <p>Disconnect rf cable from magnetic field probe and connect it to electric field probe. Move electric field probe in vicinity of source of rf interference; use that tuning unit which corresponds to frequency of interference. Place electric field probe at area which produces maximum meter indication.</p> | Noise heard in headset, and meter pointer deflects to indicate relative signal intensity. | Higher echelon repair required. |

| Step | Unit | Action or condition | Normal indication | Corrective measures |
|------|---------------------------------|-------------------------------|---|---------------------------------|
| 79 | External transformer (if used). | Turn power switch off (down). | Pilot lamp on main unit and dial lamp on tuning unit become extinguished. | Higher echelon repair required. |
| 80 | Main unit. | Set POWER switch to OFF. | None, if external transformer is used. If main unit ac power cable is connected directly to 120-volt, 50-60-cps outlet, pilot lamp on main unit and dial lamp on tuning unit become extinguished. | Higher echelon repair required. |

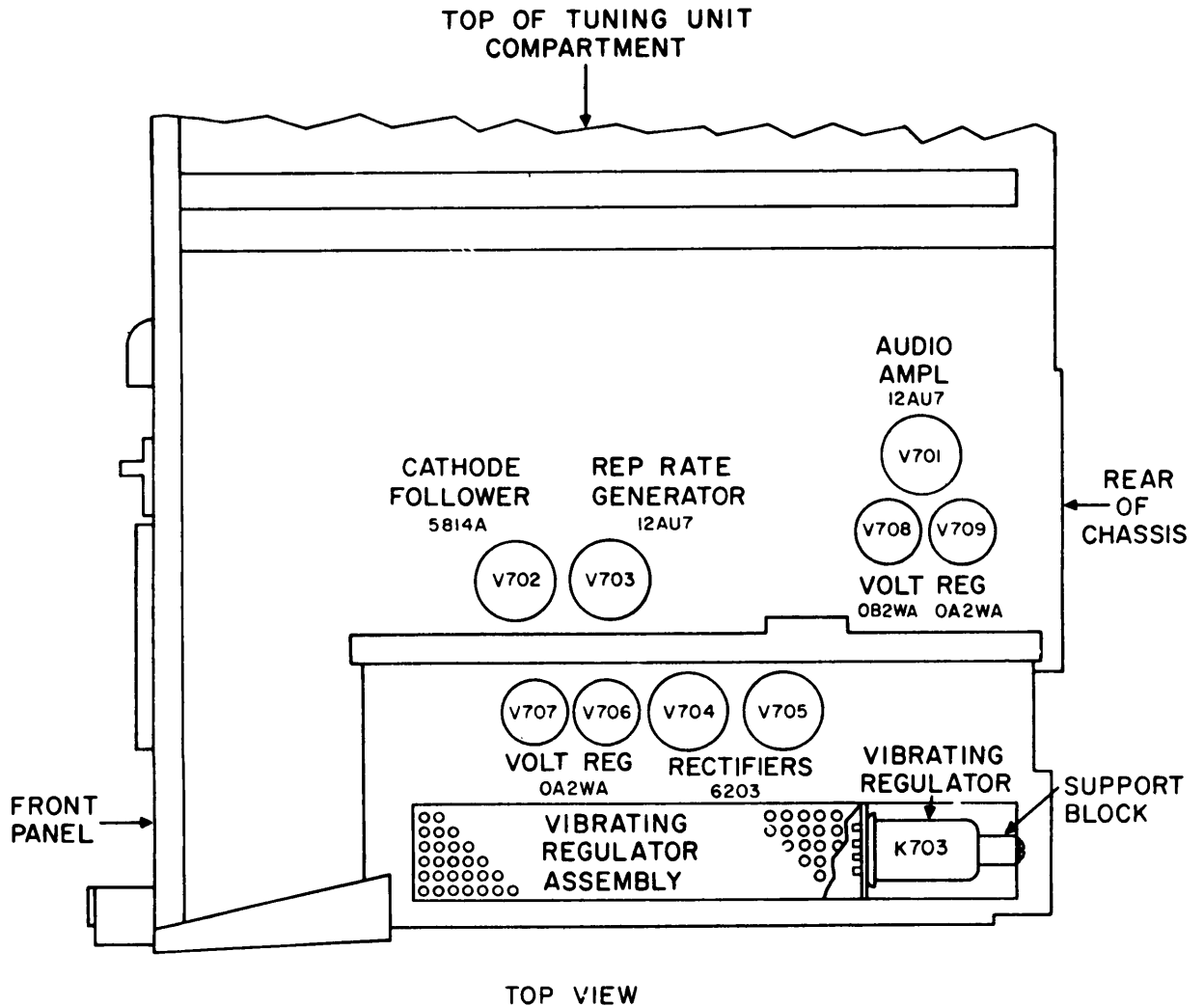

TM6625-351-12-26

Figure 28. Main unit, tube location diagram.

37. Tube Replacement

a. General. When trouble occurs, check all cabling, connections, control setting, and the general condition of the equipment before removing any tubes. The operator of the test set can only replace electron tubes V702, V703, V708, and V709 in the Main unit (fig. 28). All other electron tubes are replaced by higher echelon maintenance personnel. If tube failure in the main unit is suspected, use only the tube substitution method of replacement (b below).

Caution: Do not rock or rotate a tube when removing it from its socket; pull it straight out with a tube puller.

b. Tube Substitution Method. Replace a suspected V702, V703, V708, or V709 with a new tube. If the equipment is still inoperative, remove the new tube and put back the original tube. Repeat this procedure with each suspected tube authorized to be replaced. If the test set is still inoperative, higher echelon repair is required.

Section II. ORGANIZATIONAL MAINTENANCE

38. Scope of Organizational Maintenance

a. Second echelon maintenance duties are listed in b below. Their scope is determined by the available tools, materials, and spare parts.

b. Second echelon maintenance of the test set consists of the following:

- (1) Preventive maintenance (para 40).
- (2) Visual inspection (para 42).
- (3) Troubleshooting (para 43).
- (4) Replacement of the following items:
 - (a) Antenna Elements AT-1028/URM-85 and AT-1029/URM-85, and antenna elements for Antenna AT-1030/URM-85.
 - (b) Headset H-113/U.
 - (c) Mast Sections AB-21/GR.
 - (d) Probe, Magnetic Field, Interference Measuring MX-3409 and MX-3412/URM-85.
 - (e) Probe, Electric Field, Interference Measuring MX-3411/URM-85.
 - (f) Attenuator, Fixed CN-721/URM-85.
 - (g) Antenna AS-1158/URM-85.
 - (h) Knobs on Receiver, Radio R-1040/URM-85.
 - (i) Tube shields for electron tubes V702, V703, V708, and V709 in the main unit.

39. Tools and Materials Required

The tools and materials required for

second echelon maintenance are as follows :

a. Tools.

- (1) Alignment tool for N-type coaxial connectors and receptacles (fig. 5).
- (2) Four right-angle hexagonal wrenches, in sizes 3/64, 1/16, 5/64, and 3/32 inch across flats, for the Allen setscrews that secure control knobs to control shafts.

b. Materials.

- (1) Cleaning compound.
- (2) Cleaning cloth.
- (3) Fine sandpaper.

40. Organizational Preventive Maintenance

a. DA Form 11-266. DA Form 11-266 (fig. 29 and 30) is a preventive maintenance checklist to be used by second echelon maintenance personnel. Items not applicable to the test set are lined out in figure 30. References to the ITEM block in the figure are to paragraphs that contain additional maintenance information pertinent to the particular item. Additional preventive maintenance information concerning items 1, 3, 5, 6, 7, 10, and 11 is in paragraph 34b. Instructions for the use of the form are on page 1 of the form.

b. Items. The information below supplements DA Form 11-266. The item numbers correspond to the ITEM numbers on the form.

c. Checklist.

| | Step | Unit | Action or condition | Normal indication | Corrective measures |
|---|------|---|--|-------------------|---------------------|
| P R E P A R A T O R Y | 1 | Main unit | Set POWER switch to OFF... | None. | |
| | 2 | External transformer .. | Set power switch off (down) .. | None. | |
| | 3 | External transformer (for operation from 120-volt or 240-volt, 50- to 400-cps power lines). | Plug main unit ac power cable into AC OUTPUT recep- tacle on external trans- former (fig. 13); plug other end of cable into POWER receptacle on main unit panel. Set transformer 120V-240V switch as appli- cable (depending on power source voltage), and plug transformer power connec- tor at end of integral power cable into ac outlet. | | |
| | 4 | Ac power cable, without use of external trans- former. | For 120-volt, 50-60-cycle ac operation, where isolation from the power source is not desired, connect the ac power cable directly between the power source and the POWER receptacle on the main unit front panel. | None. | |
| | 5 | Tuning unit 2 | Plug into main unit (para 14c). Set bandswitch to 20-70. | None. | |
| | 6 | Balun for tuning unit 2.. | Mount on tripod | None. | |
| | 7 | Rf cable | Connect between SIGNAL IN- PUT receptacle on main unit and N-type receptacle on balun for tuning unit 2. Use only the red color-coded connector on the rf cable. | None. | |
| | 8 | Main unit | Set function switch to PULSE PEAK (fig. 11). | None. | |
| | 9 | Tuning unit 2 | Set GAIN control to mid- position, and SLIDEBACK control fully counterclock- wise. | None. | |
| | 10 | Main unit | Set impulse generator ON-OFF switch to ON. | None. | |
| | 11 | Main unit | Set impulse generator coarse output control to 70, and fine output control to 10 (fig. 11). | None. | |
| | 12 | Main unit | Set METER DAMP. switch to OFF. | None. | |
| | 13 | Main unit | Set VOLUME control to mid- position. | None. | |
| | 14 | Main unit | Set-SIGNAL ATTENUATOR DB control to 20. | None. | |
| | 15 | Headset | Plug one headset into either PHONES jack on main unit; use short headset cord. Plug other headset into re- maining PHONES jack on main unit; use second short headset cord in series with long headset cord. | None. | |
| | 16 | Remote meter | Connect to RECORDER EXT METER jack on main unit; use remote meter cord. | None. | |
| | 17 | Main unit | Set calibration switch to SHUNT CAL. | | |

Warning: Disconnect all power before performing the following checks. After power is disconnected, some capacitors on the chassis of the main unit still may retain dangerous voltages. Before touching exposed electrical parts on the main unit, short-circuit the parts to ground. When maintenance is completed, replace the main unit in its instrument case (fig. 2), reconnect operating power, and, check for satisfactory operation.

| Item | Maintenance procedures |
|------|--|
| 12 | <p>To inspect the seating of the electron tubes in the main unit, remove the tuning unit from its compartment in the left side of the main unit (para 14c). Working from the rear of the main unit, remove the two 8-32 machine screws that secure the rear of the main unit to the instrument case. Loosen the six olive-drab finish captive screws that secure the frame of the main unit to the instrument case. One of the six screws is located to the left of the empty tuning unit compartment; the other five screws are located around the outer edge of the main unit front panel.</p> <p>Pull the handle forward, at the bottom center of the main unit, and brace against the instrument case. Be careful when withdrawing the main unit from the instrument case, and be prepared to lift a weight of approximately 50 pounds. Place the main unit panel-chassis assembly on a clean workbench for the inspection of pluckout parts (fig. 28).</p> <p><i>Note.</i> The vibrating-type voltage regulator is protected by a perforated cover. After this cover is removed, be careful not to touch or otherwise disturb the precision resistors near the voltage regulator.</p> |
| 13 | <p>The baluns for tuning units 2 and 3 (fig. 4) can be inspected separately from Antenna Elements AT-1029/URM-85 and AT-1038/URM-85. Do not attempt to remove the balun for tuning unit 4 from its corner reflector; also do not attempt to remove the antenna elements from the integral assembly of Antenna AT-1030/URM-85 (fig. 1). Check to see that the antenna elements are straight and that the telescoping sections can be collapsed and extended to their minimum and maximum lengths (para 5a).</p> |
| 15 | <p>Inspect the resistors at the underside of the main unit only after performing the procedures outlined in item 12 above. Remove the perforated cover of the voltage regulator assembly, at the top side of the chassis (fig. 28), to check the precision resistors.</p> |
| 23 | <p>Inspect the spring-contact fingers of the grounding strips at the rear of the tuning unit panels for good spring tension and cleanliness. Remove any accumulation of dirt or grease by using cleaning compound.</p> |

41. Lubrication

This equipment does not require lubrication. Each tuning unit houses a gear train assembly which has been permanently lubricated at the factory.

42. Organizational Repairman's Visual Inspection

a. Before operating the test set, inspect it. Inspection will save time and may also avoid further damage to the equipment. When the equipment fails to operate properly, turn off the power and inspect the following for obvious defects:

- (1) Seating of all electron tubes in their sockets.
- (2) Wiring connection to the terminal boards .
- (3) Wiring connections to the switches, the pilot lamp, and the meter on the front panel.
- (4) Rotary switch contacts for signs of wear, poor connection with rotor contact, blackening, or corrosion.
- (5) Terminal boards for cracks or loose terminals,
- (6) Resistors, for indications of excessive heat; and capacitors, for bulges or splitting.

b. If the above checks do not locate the trouble, proceed to the equipment performance checklist (para 43).

43. Equipment Performance Checklist

a. *General.* The equipment performance checklist provides a procedure for systematically checking equipment performance. All corrective measures that the second echelon repairman can perform are given in the *Corrective measures* column.

b. *Procedure.* When using the checklist (c below) perform the steps in the order given. If the corrective measures indicated do not restore normal equipment performance, troubleshooting is required by higher echelon personnel. Note on the repair tag how the equipment performed and the corrective measures that were taken.

| | | | | | |
|--|----|--|--|--|--|
| T A R R T | 19 | (if used). Main unit and tuning unit 2. | power 13). Set POWER switch to ON . . . | Pilot lamp on main unit and dial lamp on tuning unit become illuminated. | Check only main unit pilot lamp and replace, if necessary; access to pilot lamp is obtained by removal of indicator light lens from front panel. If dial lamp on tuning unit does not light, higher echelon repair is required. Inspect fuses in external transformer (if used) and main unit; replace, if necessary. |
| | | | | Hum is heard, if ear is placed close to right rear area of main unit (as viewed from front of equipment). | Replace vibrating type regulator K703 (fig. 26). If pilot lamp on main unit and MEGACYCLES lamp on tuning unit become unusually bright or dim, this is a further indication of the need for replacing vibrating type regulator K703. Tuning unit not seated firmly in main unit compartment. Push tuning unit all the way in. Higher echelon repair required. |
| | | | | Meters indicate activity, showing that impulse generator signal is being coupled, through the tuning unit, to the meter circuit. | If main unit panel meter is operative but remote meter is not, check connections of external meter cord. Higher echelon repair required. |
| | | | | | |
| E Q U I P P E R F. | 20 | Main unit | Set function switch to ZERO ADJ. Rotate ZERO ADJ. control to obtain 0-db indication on both meters. | Meters can be adjusted to 0 db (on upper scale of meters). | Replace electron tubes V702 and V703 in main unit (para 37). Higher echelon repair required. |
| | 21 | Main unit | Reset function switch to PULSE PEAK. | Noise heard in both headsets. Note. When it is established that both headsets and three headset cords are not defective, disconnect short and long headset cords (connected in series) and use only one headset for the rest of checks. Meters indicate noise level. | Replace defective headset. Higher echelon repair required. |
| | 22 | Main unit | Decrease impulse generator coarse and fine output control settings. | Noise decreases in headset and meter reading decreases. | Higher echelon repair required. Higher echelon repair required. |
| | 23 | Main unit | Increase impulse generator coarse and fine controls to their previous settings of 70 and 10, respectively. | Noise increases in headset, and meter reading increases. | Higher echelon repair required. |

| | Step | Unit | Action or condition | Normal indication | Corrective measures |
|--|------|---------------------|---|---|---|
| E Q U I P M E N T P E R F O R M A N C E | 24 | Main unit | <p>Rotate SIGNAL ATTENUATOR DB control successively from 20 to 0 SUBST. ONLY, 40, 60, and then to 80 (para 16a). Reset the SIGNAL ATTENUATOR DB control to 20 after checking the five listed switch positions.</p> <p>Throughout the following steps maintain an on-scale meter pointer deflection by rotating the SIGNAL ATTENUATOR DB control to higher settings (40, 60, or 80, as necessary). If intensity of incoming signal is so high that meter pointer deflects off-scale to the right at control setting of 80, insert 40-db Attenuator, Fixed CN-721/URM-85 between SIGNAL INPUT receptacle and red color-coded connector on rf cable.</p> | <p>Meter reading and noise signal in headset change at each setting.</p> <p>Meter reading is maintained on-scale.</p> | <p>Higher echelon repair required.</p> <p>If meter reading does not stay on-scale using Attenuator, Fixed CN-721/URM-85, replace attenuator. Higher echelon repair required.</p> |
| | 25 | Main unit | Set impulse generator ON-OFF switch to OFF, calibration switch to SERIES CAL & OPERATE, and function switch to ZERO ADJ. | Meter indicates 0 db. | Rotate ZERO ADJ. control to reset meter pointer to 0 db. |
| | 26 | Main unit | Set function switch to CW AVERAGE. | Meter reading changes if rf signal is present. | Perform step 27. |
| | 27 | Tuning unit 2 | Rotate TUNING control to tune in a narrowband (modulated cw) signal, known to be operating at a particular frequency within range from 20 to 70 mc. | Signal is heard in headset. | Check antenna sections (if applicable) for resonant length (para 22d). Check rf cable connections. Replace any Mast Section AB-21/GR if threaded ferrules are bent or out of alignment. Higher echelon repair required. |
| | 28 | Main unit | <p>Rotate GAIN control clockwise then counterclockwise. Rotate VOLUME control clockwise and then counterclockwise. Set VOLUME control for a comfortable listening level.</p> | <p>Meters indicate activity. Noise level changes in headset. Noise level increases and then decreases in headset.</p> | Higher echelon repair required. |
| | 29 | Main unit | Set function switch to CW PEAK. | Meter reading changes with respect to step 27. | Perform step 28. |
| | 30 | Tuning unit 2 | Keep TUNING control tuned to modulated cw signal (step 27). | Signal is heard in headset; meter now indicates peak envelope voltage of modulated signal. | Higher echelon repair required. |
| | 31 | Main unit | Set function switch to METERED SLIDEBACK. Rotate SLIDEBACK control to approximately midposition, then slowly counterclock- | Signal heard in headset decreases in volume. Meter indicates more accurate peak | Higher echelon repair required. |

| | Step | Unit | Action or condition | Normal indication | Corrective measures |
|--|--|-------------------------------|---|---|---------------------------------|
| E Q U I P M E N T P E R F O R M A N C E | 32 | Main unit | wise so that signal in head-set is at threshold of audibility. Set SIGNAL ATTENUATOR DB control to 0 CW ONLY. Set function switch to CW AVERAGE. | envelope voltage of signal than in step 30. See step 33. | |
| | 33 | Tuning unit 2 | Rotate TUNING control to tune in a low-amplitude rf cw signal, over frequency range of 20 to 70 mc. | Meter reading changes with respect to indication observed in step 31. If meter pointer fluctuations due to transients are noticed, perform step 34. | Higher echelon repair required. |
| | 34 | Main unit | Set METER DAMP. switch to ON or MOM. If meter pointer fluctuates during procedure described in step 33). | Meter pointer stops fluctuating in presence of intermittent transients. | Higher echelon repair required. |
| | 35 | Main unit | Set METER DAMP. switch to OFF. | None. | |
| | 36 | Tuning unit 2 | Set bandswitch to 70-220. Repeat steps 10, 17, and 20 through 31, except tune in a modulated cw signal known to be operating at a particular frequency within range from 70 to 220 mc. | Same as steps 20 through 31. | Same as steps 20 through 31. |
| | 37 | Main unit | Set POWER switch to OFF ... | Pilot lamp and tuning unit dial become extinguished. | Higher echelon repair required. |
| | 38 | Tuning unit 2 | Remove tuning unit from main unit (para 14c). | None. | |
| | 39 | Tuning unit 3 | Plug into main unit (para 14c). | None. | |
| | 40 | Balun for tuning unit 2.. | Remove from tripod | None. | |
| | 41 | Balun for tuning unit 3.. | Remove from tripod | None. | |
| | 42 | Main unit and tuning unit 3. | Set POWER switch to ON | Pilot lamp on main unit and dial lamp on tuning unit become illuminated. | Same as step 19. |
| | 43 | Rf cable | Disconnect rf cable from balun for tuning unit 2; connect rf cable to N-type receptacle on balun for tuning unit 3. Repeat steps 10, 17, and 20 through 31, except tune in a modulated cw signal known to be operating at a particular frequency with range from 200 to 400 mc. | Same as steps 20 through 31. | Same as steps 20 through 31. |
| | 44 | Main unit | Set POWER switch to OFF ... | Pilot lamp and tuning unit dial lamp become extinguished. | Higher echelon repair required. |
| | 45 | Tuning unit 3 | Remove tuning unit from main unit (para 14c). | None. | |
| | 46 | Tuning unit 4 | Plug into main unit (para 14c). Set bandswitch to 400-700. | None. | |
| | 47 | Balun for tuning unit 3.. | Remove from tripod | None. | |
| 48 | Dipole and corner reflector antenna for tuning unit 4. | Assemble and mount on tripod. | None. | | |

| | Step | Unit | Action or condition | Normal indication | Corrective measures |
|--|------|---|--|---|---------------------------------|
| E Q U I P M E N T P E R F O R M A N C E | 49 | Main unit | Set POWER switch to ON | Pilot lamp on main unit and dial lamp on tuning unit become illuminated. | Same as step 19. |
| | 50 | Rf cable | Disconnect rf cable from balun for tuning unit 3, and connect rf cable to N-type receptacle on dipole and corner reflector antenna for tuning unit 4. Repeat steps 10, 17, and 20 through 31, except tune in a modulated cw signal known to be operating at frequency within range from 400 to 700 mc. | Same as steps 20 through 31. | Same as steps 20 through 31. |
| | 51 | Tuning unit 4 | Set bandswitch to 700-1,000. Repeat steps 10, 17, and 20 through 31, except tune in a modulated cw signal known to be operating at a particular frequency within range from 700 to 1,000 mc. | Same as steps 20 through 31. | Same as steps 20 through 31. |
| | 52 | Rf cable | Disconnect rf cable from dipole antenna and reflector for tuning unit 4. | None. | |
| | 53 | Dipole antenna and reflector for tuning unit 4. | Remove from tripod | None. | |
| | 54 | Discone (broadband) antenna. | Attach to ground plane and mount both items on tripod. | None. | |
| | 55 | Unbalanced injection block. | Mate noncolor-coded connector on unbalanced injection block to terminal at base of discone (broadband) antenna. | None. | |
| | 56 | Rf cable | Connect both red and green color-coded connectors of rf cable to corresponding connectors on unbalanced injection block. Be sure to mate green color-coded connector at receiver end or rf cable to IMPULSE OUTPUT receptacle on main unit. | None. | Check cable connections. |
| | 57 | Tuning unit 4 | Repeat step 51, but use discone (broadband) antenna. | Same as step 51 . . | Same as step 51. |
| | 58 | Main unit | Set POWER switch to OFF | Pilot lamp on main unit and dial lamp on tuning unit become extinguished. | Higher echelon repair required. |
| | 59 | Tuning unit 4 | Remove tuning unit from main unit (para 14c). | None. | |
| | 60 | Tuning unit 1 | Plug into main unit (para 14c). Turn bandswitch to . 15-. 36. | None. | |
| | 61 | Rf cable | Disconnect from unbalanced injection block. | None. | |
| | 62 | Unbalanced injection block. | Remove from discone (broadband) antenna. | None. | |
| | 63 | Vertical antenna base . . | Mount on tripod | None. | |
| | 64 | Rf cable | Connect to similarly color-coded receptacles on base of vertical antenna. | None. | |
| | 65 | Mast Section AB-21/GR. | Connect six sections to socket at top of vertical antenna base (fig. 10). | None. | |

| | Step | Unit | Action or condition | Normal indication | Corrective measures |
|--|------|--|---|--|------------------------------|
| E Q U I P M E N T P E R F O R M A N C E | 66 | Main unit | Set POWER switch to ON . . . | Pilot lamp on main unit and one dial lamp on tuning unit become illuminated. | Same as step 19. |
| | 67 | Vertical antenna | Turn bandswitch to .15-.36. Repeat steps 10, 17, and 20 through 31, except tune in a modulated cw signal known to be operating at a particular frequency within range from 150 kc to 360 kc. | Same as steps 20 through 31. | Same as steps 20 through 31. |
| | 68 | Tuning unit 1 and vertical antenna. | Repeat step 67, except rotate the bandswitch on both tuning unit and vertical antenna base successively to five remaining positions. In each position, tune in a modulated cw signal known to be operating at a particular frequency within range of each band. | Same as step 67 . . | Same as step 67. |
| | 69 | Vertical antenna | Disconnect both lengths of rf cable from base of vertical antenna. Remove vertical antenna and ground plane from tripod. | None. | |
| | 70 | Loop antenna | Mount loop antenna on tripod. | None. | |
| | 71 | Rf cable | Connect green and red color-coded connectors to receptacles on base of loop antenna. | None. | |
| | 72 | Loop antenna | Rotate loop on its swivel joint to obtain maximum pointer deflection on main unit and remote meter. Repeat steps 67 and 68. | Same as steps 20 through 31. | Same as steps 20 through 31. |
| | 73 | Rf cable and both 50-ohm conductive couplers. | Disconnect rf cable from loop antenna; connect red color-coded connector only to N-type receptacle on 50-ohm conductive coupler. Connect coupler to two-wire power or audio-signal line of approximately 50 ohms impedance, on which modulated cw signals at frequencies of tuning unit used are known to be present. Repeat steps 10, 17, and 20 through 31 successively with tuning unit 1, and either tuning unit 2, 3, or 4. Be sure to use Coupler, Radio Frequency Interference CU-891/URM-85 when operating with tuning unit 1, and Coupler, Radio Frequency Interference CU-896/URM-85 when operating with tuning unit 2, 3, or 4. | Same as steps 20 through 31. | Same as steps 20 through 31. |
| | 74 | Rf cable and both 500-ohm conductive couplers. | Disconnect rf cable from 500-ohm conductive coupler and connect to N-type receptacle on 500-ohm conductive coupler. Connect coupler to two-wire power on audio- | Same as steps 20 through 31. | Same as steps 20 through 31. |

| | Step | Unit | Action or condition | Normal indication | Corrective measures |
|--|------|-------------------------------------|--|--|---|
| E Q U I P M E N T P E R F O R M A N C E | | | signal line of approximately 500 ohms impedance, on which modulated cw signals at frequencies of tuning unit are known to be present. Repeat steps 10, 17, and 20 through 31 successively with tuning unit 2, 3, or 4. Be sure to use Coupler, Radio Frequency Interference CU-892/URM-85 when operating with tuning unit 1, and Coupler, Radio Frequency Interference CU-897/URM-85 when operating with tuning unit 2, 3, or 4. | | |
| | 75 | Rf cable and magnetic field probes. | Disconnect rf cable from 500-ohm conductive coupler and connect it to one of magnetic field probes, depending on unit used. Use Probe, Magnetic Field, Interference Measuring MX-3409/URM-85 when operating with tuning unit 1, and Probe, Magnetic Field, Interference Measuring MX-3412/URM-85 when operating with tuning unit 2, 3, or 4. | Noise heard in headset, and meter pointer deflects to indicate relative signal intensity. | Replace that magnetic field probe which causes no meter indication. Higher echelon repair required. |
| | 76 | Main unit | Set function switch to PULSE PEAK, and SIGNAL ATTENUATOR DB control to 0 SUBST. ONLY. | None. | |
| | 77 | Magnetic field probe ... | Move magnetic field probe in vicinity of source of rf interference; use that tuning unit which corresponds to frequency of interference. Rotate loop through 180° for maximum meter indication. | Noise heard in headset, and meter pointer deflects to indicate relative signal intensity. | Higher echelon repair required. |
| | 78 | Rf cable and electric field probe. | Disconnect rf cable from magnetic field probe and connect it to electric field probe. Move electric field probe in vicinity of source of rf interference; use that tuning unit which corresponds to frequency of interference. Place electric field probe at area which produces maximum meter indication. | Noise heard in headset, and meter pointer deflects to indicate relative signal intensity. | Replace electric field probe. Higher echelon repair required. |
| S T O P | 79 | External transformer (if used). | Turn power switch off (down) .. | Pilot lamp on main unit and dial lamp on tuning unit become extinguished. | Higher echelon repair required. |
| | 80 | Main unit | Set POWER switch to OFF | None, if external transformer is used. If main unit ac power cable is connected directly to 120-volt, 50-60-cps outlet, pilot lamps on main unit and dial lamp on tuning unit become extinguished. | Higher echelon repair required. |

| MAINTENANCE CHECK LIST FOR SIGNAL EQUIPMENT TEST EQUIPMENT <small>(AR 750-625)</small> | | | |
|---|----------|-----------------|-----------------------|
| EQUIPMENT NOMENCLATURE <i>10000 TELEPHONE MEASUREMENT SET AN URM-25</i> | | | |
| EQUIPMENT SERIAL NUMBER <i>57</i> | | | |
| INSTRUCTIONS | | | |
| <p>This form may be used for a period of one month by using the correct dates and weeks of the month. It is to be used as a Preventive Maintenance check list for Signal equipment in actual use, or for a check on equipment prior to issue.</p> <ol style="list-style-type: none"> 1. For detailed Preventive Maintenance instructions see: <ol style="list-style-type: none"> a. The Technical Manual (in TM 11 series) for the equipment. <i>(See DA Pamphlet Number 310-4)</i> b. The Supply Bulletin (SB 11-100 series) for the equipment. <i>(See DA Pamphlet Number 310-4)</i> c. The Department of the Army Lubrication Order. <i>(See DA Pamphlet Number 310-4)</i> 2. The following action will be taken by either the Communications Officer/Chief for 1st echelon, or the Inspector for higher echelon: <ol style="list-style-type: none"> a. Enter Equipment Nomenclature and Serial Number. b. Strike out items that do not apply to the equipment. 3. Operator-Inspector will enter in the columns entitled CONDITION, on the proper line, a notation regarding the condition, using symbols specified under LEGEND. 4. After operator completes each daily inspection he will initial over the appropriate dates under "Daily Condition for Month", then return form to his supervisor. | | | |
| TYPE OF INSPECTION <i>2D ECHELON</i> | | | |
| OPERATOR | ECH-ELON | DATE | SIGNATURE |
| | <i>✓</i> | <i>11/16/57</i> | <i>James R. Ke...</i> |
| | | | |
| | | | |
| | | | |
| | | | |
| | | | |

OFFICE 1957 O-427138

DA FORM 11-266
MAY 57

TM6625-351-12-30

Figure 29. DA Form 11-266, pages 1 and 4 (second echelon).

| LEGEND for marking conditions: Satisfactory, ✓. Adjustment, Repair or Replacement required, X. Defect corrected, (X) | | | | | | DAILY CONDITION FOR MONTH OF <i>MARCH 1961</i> | | | | | | | | | | | | | | | | | | | | | | | | | | | | | | | | |
|---|--|--|--|--|--|--|----|----|-----|-----|---|---|---|---|----|----|--|---|----|----|----|----|----|----|----|----|----|-----------|----|----|----|----|----|----|----|----|----------------|---|
| DAILY | | | | | | 1 | 2 | 3 | 4 | 5 | 6 | 7 | 8 | 9 | 10 | 11 | 12 | 13 | 14 | 15 | 16 | 17 | 18 | 19 | 20 | 21 | 22 | 23 | 24 | 25 | 26 | 27 | 28 | 29 | 30 | 31 | 20-30 ECH-ELON | |
| NO | ITEM | | | | | | | | | | | | | | | | | | | | | | | | | | | | | | | | | | | | | |
| 1 | CLEAN DIRT AND MOISTURE FROM EXPOSED SURFACES OF HOUSINGS, CASES, CABINETS, CONTROL PANELS, INTERCONNECTING PLUGS, CABLES, HEADSETS, METER WINDOWS, ETC. PARA 34b | | | | | | | | | | | | | | | | | | | | | | | | | | | | | | | | | | | | | ✓ |
| 2 | INSPECT FOR LOOSENESS OF EXTERIOR ITEMS SUCH AS SWITCHES, KNOBS, JACKS, CONNECTORS AND PILOT LIGHTS | | | | | | | | | | | | | | | | | | | | | | | | | | | | | | | | | | | | | ✓ |
| 3 | INSPECT CONTROLS FOR BINDING, SCRAPING. TAP CONTROLS LIGHTLY FOR CUT-OUT DUE TO LOOSE CONTACTS. PARA 34b | | | | | | | | | | | | | | | | | | | | | | | | | | | | | | | | | | | | | ✓ |
| 4 | DURING OPERATION BE ALERT FOR ANY UNUSUAL PERFORMANCE OR CONDITION | | | | | | | | | | | | | | | | | | | | | | | | | | | | | | | | | | | | | ✓ |
| WEEKLY | | | | | | CONDITION EACH WEEK | | | | | 20-30 ECH | ADDITIONAL ITEMS FOR 20-AND-30 ECHELON INSPECTIONS | | | | | | | | | | | | | | | | CONDITION | | | | | | | | | | |
| 5 INSPECT CORDS, CABLES, WIRE AND SHEATH MOUNTS FOR BREAKS, CUTS, KINKS, DETE-RIORATION, STRAIN AND FRAYING. PARA 34b | | | | | | 1ST | 2D | 3D | 4TH | 5TH | ✓ | 15. INSPECT RESISTORS, BUSHINGS, INSULATORS FOR CRACKS, CHIPPING, BLISTERING, DISCOLORATION AND MOISTURE. PARA 40b | | | | | | | | | | | | | | | | ✓ | | | | | | | | | | |
| | | | | | | 6 INSPECT CANVAS AND LEATHER ITEMS FOR FUNGUS, FRAYING, TEARS, BROKEN ZIPPERS AND SNAP FASTENERS. PARA 34b | | | | | | | | | | | ✓ | 16. INSPECT JACKS AND CONNECTORS FOR SNUG FIT AND GOOD CONTACTS | | | | | | | | | | | | | | | | ✓ | | | | |
| 7 HAND CHECK FOR LOOSENESS OF EXTERIOR ITEMS SUCH AS HANDLES, LATCHES AND . PARA 34b | | | | | | | | | | | | | | | | | ✓ | 17. INSPECT VARIABLE CAPACITORS FOR DIRT AND MOISTURE. | | | | | | | | | | | | | | | | ✓ | | | | |
| | | | | | | 8 INSPECT FOR LUBRICATION IN ACCORDANCE WITH APPLICABLE OR LUBRICATION ORDER. | | | | | | | | | | | ✓ | 18. INSPECT AIR FILTERS FOR CLEANLINESS. | | | | | | | | | | | | | | | | | | | | |
| 9 INSPECT DRY BATTERIES FOR DIRT, LOOSE TERMINALS AND LEAKAGE. | | | | | | | | | | | | | | | | | ✓ | 19. INSPECT SCREWTYPE TERMINALS OF TRANSFORMERS, FIRED CAPACITORS, RESISTORS, CHOKES, POTENTIOMETERS AND RHEOSTATS FOR CORROSION, DIRT AND LOOSE CONTACTS. | | | | | | | | | | | | | | | | | | | | |
| | | | | | | 10 INSPECT EXPOSED METAL SUR- FACES FOR RUST AND CORROSION. PARA 34b | | | | | | | | | | | ✓ | 20. CLEAN AND TIGHTEN SWITCHES, BLOWERS, RELAY CASES; CLEAN INTERIOR OF CHASSIS AND CABINETS. | | | | | | | | | | | | | | | | ✓ | | | | |
| 11 INSPECT METERS FOR DAMAGED GLASS AND CASES. PARA 34b | | | | | | | | | | | | | | | | | X | 21. INSPECT GENERATORS, MOTORS AND DYNAMOTORS FOR BRUSH WEAR, SPRING TENSION, ARMING AND COMMUTATOR WEAR. | | | | | | | | | | | | | | | | | | | | |
| | | | | | | ADDITIONAL ITEMS FOR 20-AND-30 ECHELON INSPECTIONS | | | | | | | | | | | | 22. INSPECT TERMINAL BLOCKS FOR LOOSE CONNECTIONS, CRACKS AND BREAKS. | | | | | | | | | | | | | | | | | | | | |
| 12 INSPECT SEATING OF READILY ACCESSIBLE ITEMS OF A PLUCK-OUT NATURE, CRYSTALS, FUSES, CONNECTORS, AND LAMPS, ETC. DO NOT REMOVE, ROCK OR TWIST TO INSPECT. USE ONLY A DIRECT PRESSURE TO INSURE THE ITEM IS FULLY SEATED. PARA 40b | | | | | | | | | | | | | | | | | ⊕ | 23. INSPECT GASKETS AND BUSHINGS - FOR WEAR AND DAMAGE. PARA 40b | | | | | | | | | | | | | | | | ✓ | | | | |
| | | | | | | 13 INSPECT FOR CLEANLINESS AND TIGHTNESS OF SUCH ITEMS AS SHOCK MOUNTS, ANTENNA, ANTENNA MOUNTS AND PARA 40b | | | | | | | | | | | ✓ | 24. INSPECT CATHODE RAY TUBES FOR BURNED SCREEN SPOTS. | | | | | | | | | | | | | | | | | | | | |
| 14 INSPECT RELAY AND CIRCUIT BREAKER ASSEMBLIES FOR DIRT, CORROSION, WORN OR BURNED CONTACTS. | | | | | | | | | | | | | | | | | | 25. BEFORE STORING OR SHIPPING REMOVE ALL BATTERIES. | | | | | | | | | | | | | | | | | | | | |
| | | | | | | | | | | | | | | | | | IF DEFICIENCIES NOTED ARE NOT CORRECTED DURING THE INSPECTION, INDICATE ACTION TAKEN FOR CORRECTION. (Continue on page 4, if more space is needed) | | | | | | | | | | | | | | | | | | | | | |
| | | | | | | | | | | | ITEM 11 POWER CLASS ON MAIN UNIT METER TORNED EQUIPMENT IN FOR RUMBER ECH-ELON BRN. | | | | | | | | | | | | | | | | | | | | | | | | | | | |

Figure 30. DA Form 11-266, pages 2 and 3 (second echelon).

CHAPTER 4

SHIPMENT AND LIMITED STORAGE AND DEMOLITION TO PREVENT ENEMY USE

Section I. SHIPMENT AND LIMITED STORAGE

44. Disassembly of Equipment

To prepare the test set for shipment or limited storage, proceed as follows:

- a. Set the POWER switch on the main unit to OFF.
- b. Set the power switch on the external transformer (if used) to the off position (down).
- c. Disconnect the external transformer (if used) from the ac power source.
- d. Disconnect one end of the ac power cable from the A.C. OUTPUT on the external transformer; disconnect the other end from the POWER receptacle on the main unit (fig. 11).
- e. Remove the rf cable from the signal pickup device and from the SIGNAL INPUT and IMPULSE OUTPUT receptacles on the main unit.
- f. Remove the signal pickup device and the ground plane (if used) from the tripod.
- g. Unplug the headsets from the main unit PHONES jacks.
- h. Remove the four legs from the transit chest (fig. 1) and store them inside the transit chest cover.
- i. Place the main unit in its transit chest and fasten the cover.
- j. Place the remaining three tuning units in their transit cases and fasten the covers.
- k. Place all the accessories and minor components in their respective transit cases and fasten the covers. (Storage plans for each transit case that houses accessories are mounted on the inside cover of the cases.)
- l. Fold up the tripod (fig. 1) and loop the web strap around the legs. Tighten the web strap to lock the feet of the tripod together.
- m. Place the tripod in the tripod storage bag, close the end cover, and secure the zipper (fig. 5).

45. Repackaging for Shipment or Limited Storage

The exact procedure for repackaging depends on the material available and the conditions under which the equipment is to be shipped or stored. Use the procedures outlined below whenever circumstances permit. The information concerning the original packaging (para 12) will also be helpful.

a. *Material Requirements.* The following materials are required for packaging Radio Interference Measuring Set AN/URM-85. For stock numbers of materials, consult SB 38-100.

| Material | Quantity |
|------------------------------------|-----------|
| Waterproof paper | 144 sq ft |
| Waterproof pressure-sensitive tape | 60 ft |
| Cotton twine | 50 ft |
| Corrugated cardboard | 120 sq ft |
| Gummed paper tape | 80 ft |
| Filler material | 30 lb |
| Metal strapping (5/8-0.020-inch) | 120 ft |

Note. Strapping seals are required.

b. *Packaging.* Package each transit case as follows:

- (1) Line the bottom of a corrugated carton, large enough to hold the transit case, with corrugated filler. Place the transit case within the corrugated carton.
- (2) Cushion the transit case on all surfaces with pads fabricated of corrugated fiberboard. Seal the entire closure with gummed paper tape and blunt all corners of the box.
- (3) Place the corrugated carton within a moisture-vaporproof barrier and heat-seal the closure. Place the moisture-vaporproofed transit case within a second close-fitting,

corrugated carton. Seal the entire closure with waterproof, pressure-sensitive tape.

- (4) Overwrap this corrugated carton with waterproof barrier material. Completely seal all joints, seams, and closures with waterproof, pressure-sensitive tape.
- (5) Place the packaged equipment within a wooden packing case lined

with a 2-inch thickness of excelsior compacted to 3 pounds per cubic foot. Nail down the wooden cover. Mark the wooden packing cases according to the packaging data in paragraph 12a.

- (6) Strap the wooden packing case in accordance with approved specifications when overseas shipment is involved.

Section II. DEMOLITION OF MATERIEL TO PREVENT ENEMY USE

46. Authority for Demolition

The demolition procedures outlined in paragraph 47 will be used to prevent further use of the equipment. Demolition of the equipment will be accomplished only upon the order of the commander.

47. Methods of Destruction

Any or all of the methods of destruction given below may be used.

a. Smash. Smash the front-panel knobs, dials, and meter, the external meter, the headsets, and the spare parts; use sledges, axes, hammers, crowbars, or any other heavy tools available. Because the transit cases will resist smashing, remove the

various units from their cases and smash their interiors.

b. Cut. Cut the headset, meter, test harness, rf and power cables in a number of places; use axes, handaxes, machetes, or knives.

c. Burn. Burn the technical manuals, cut the wiring and internal wiring; use gasoline, kerosene, oil, or flamethrowers.

Warning: Be extremely careful with explosives and incendiary devices. Use these items only when the need is urgent.

d. Explode. If explosives are necessary, use grenades, TNT, or firearms.

e. Dispose. Bury or scatter destroyed parts in slit trenches or foxholes, or throw them into nearby waterways.

APPENDIX I

REFERENCES

Following is a list of applicable references available to the operator or organizational maintenance personnel of the AN/URM-85:

| | |
|--------------------|--|
| SB 38-100 | Preservation, Packaging, and Packing Materials, Supplies, and Equipment Used by the Army. |
| TB SIG 255 | Radioactive Electron Tube Handling. |
| TM 11-6625-351-20P | Organizational Maintenance Repair Parts and Special Tools List for Radio Interference Measuring Set AN/URM-85. |

APPENDIX II

MAINTENANCE ALLOCATION

Section I. INTRODUCTION

1. General

a. This appendix assigns maintenance functions and repair operations to be performed by the lowest appropriate maintenance echelon.

b. Columns in the maintenance allocation chart are as follows:

(1) *Part or component.* This column shows only the nomenclature or standard item name. Additional descriptive data are included only where clarification is necessary to identify the part. Components and parts comprising a major end item are listed alphabetically. Assemblies and subassemblies are in alphabetical sequence with their components listed alphabetically immediately below the assembly listing.

(2) *Maintenance function.* This column indicates the various maintenance functions allocated to the echelon capable of performing the operations.

(a) *Service.* To clean, to preserve, and to replenish fuel and lubricants.

(b) *Adjust.* To regulate periodically to prevent malfunction.

(c) *Inspect.* To verify serviceability and to detect incipient electrical or mechanical failure by scrutiny.

(d) *Test.* To verify serviceability and to detect incipient electrical or mechanical failure by use of special equipment such as gages, meters, etc.

(e) *Replace.* To substitute service assemblies, subassemblies, and parts for unserviceable components.

(f) *Repair.* To restore an item to serviceable condition through correction of a specific failure

or unserviceable condition. This function includes but is not limited to, inspecting, cleaning, preserving, adjusting, replacing, welding, riveting, and straightening.

(g) *Align.* To adjust two or more components of an electrical system so that their functions are properly synchronized.

(h) *Calibrate.* To determine, check, or rectify the graduation of an instrument, weapon, or weapons systems, or components of a weapons system.

(i) *Rebuild.* To restore an item to a standard as near as possible to original or new condition in appearance, performance, and life expectancy. This is accomplished through the maintenance technique of complete disassembly of the item, inspection of all parts or components, repair or replacement of worn or unserviceable elements using original manufacturing tolerances and/or specifications and subsequent reassembly of the item.

(j) *Overhaul.* To restore an item to completely serviceable condition as prescribed by serviceability standards developed and published by heads of technical services. This is accomplished through employment of the technique of "Inspect and Repair Only as Necessary" (IROAN). Maximum utilization of diagnostic and test equipment is combined with minimum disassembly of the item during the overhaul process.

(3) *1st, 2d, 3d, 4th, and 5th echelon.* The symbol X indicates the echelon responsible for performing

that particular maintenance operation, but does not necessarily indicate that repair parts will be stocked at that level. Echelons higher than the echelon marked by X are authorized to perform the indicated operation.

(4) *Tools required.* This column indicates codes assigned to each individual tool equipment, test equipment, and maintenance equipment referenced. The numbers in column 8 of the maintenance allocation chart indicate the tool, test, and maintenance equipment required to perform the maintenance function. These numbers are identified in section III, allocation of tools for maintenance functions.

(5) *Remarks.* Column 9 contains any notations necessary to clarify the data cited in the preceding columns .

c. Columns in the allocation of tools for maintenance functions are as follows:

(1) *Tools required for maintenance*

functions. This column lists tools, test, and maintenance equipment required to perform the maintenance functions.

(2) *1st, 2d 3d, 4th, 5th echelon.* The dagger (†) indicates the echelons allocated the facility.

(3) *Tool code.* This column lists the tool code assigned.

2. Mounting Hardware

The basic entries of the maintenance allocation chart do not include mounting hardware such as screws, nuts, bolts, washers, brackets, clamps, etc.

3. Maintenance by Using Organizations

When this equipment is used by signal services organizations organic to theater headquarters or communication zones, those maintenance functions allocated up to and including fourth echelon are authorized to the organization operating this equipment.

Section II. MAINTENANCE ALLOCATION CHART

84

| (1) PART OR COMPONENT | (2) MAINTENANCE FUNCTION | (3) 1ST ECH | (4) 2ND ECH | (5) 3RD ECH | (6) 4TH ECH | (7) 5TH ECH | (8) TOOLS REQUIRED | (9) REMARKS |
|---|--|-------------------|-------------------|-------------------|-------------------|-------------------|--|--|
| RADIO INTERFERENCE MEASURING SET AN/URM-85 | service adjust inspect test repair | | X | | X | | 11 1 thru 13 14 | Tool code 9 allocated to 5th echelon only 2nd echelon repair is limited to replacement to replacement of "Pluck-out" items |
| | align calibrate overhaul | | | | X X X | X | 11,12 1 thru 10,13 1 thru 10,13 11,12 | |
| ANTENNA AT-1026/URM-85 | repair | | X | | X | | 14 11,12 | 2nd echelon repair is limited to replacement of knob and thumbscrew |
| | rebuild | | | | | X | 11,12 | |
| ANTENNA AT-1030/URM-85 | repair | | X | | X | | 14 11,12 | 2nd echelon repair is limited to replacement of antenna elements and thumbscrews |
| | rebuild | | | | | X | 11,12 | |
| CABLE, ASSEMBLY, POWER, ELECTRICAL CX-6680/U | repair | | | | X | | 11,12 | |
| CABLE ASSEMBLY, SPECIAL PURPOSE, ELECTRICAL, BRANCHED CX-6681/URM-85 | repair | | | | X | | 11,12 | |
| CABLE ASSEMBLY SET, ELECTRICAL MX-3410/URM-85 | repair | | | | X | | 11,12 | |
| CASE, ELECTRONIC FREQUENCY CONVERTER CY-3092/URM-85 | repair | | | | | X | 11,12 | |
| CASE, RADIO INTERFERENCE MEASURING SET GROUPS | repair | | | | | X | 11,12 | |
| CASE, RECEIVER CY-3093/URM-85 | repair | | | | | X | 11,12 | |
| CONVERTER, FREQUENCY, ELECTRONIC CV-1101/URM-85 | repair | | | | X | | 11,12 | |
| | overhaul | | | | | X | 11,12 | |
| AMPLIFIER, INTERMEDIATE FREQUENCY | repair | | | | X | | 11,12 | |
| | rebuild | | | | | X | 11,12 | |
| TRANSFORMER, INTERMEDIATE FREQUENCY (Ref symbols T24 and T29) | replace | | | | X | | 11,12 | Repair to the extent of replacing capacitor and resistor |
| | repair | | | | X | | 11,12 | |
| ATTENUATOR, VARIABLE, INTERMEDIATE FREQUENCY | repair | | | | X | | 11,12 | |
| | rebuild | | | | | X | 11,12 | |
| GEAR TRAIN ASSEMBLY | rebuild | | | | | X | 11,12 | |
| PANEL ASSEMBLY | rebuild | | | | | X | 11,12 | |
| SELECTOR, INTERMEDIATE FREQUENCY INPUT | repair | | | | X | | 11,12 | |
| | rebuild | | | | | X | 11,12 | |
| | | | | | | | | |

| (1) | (2) | (3) | (4) | (5) | (6) | (7) | (8) | (9) |
|---|----------------------|---------|---------|---------|---------|---------|----------------|--|
| PART OR COMPONENT | MAINTENANCE FUNCTION | 1ST ECH | 2ND ECH | 3RD ECH | 4TH ECH | 5TH ECH | TOOLS REQUIRED | REMARKS |
| AN/URM-85 (continued) | | | | | | | | |
| SELECTOR, INTERMEDIATE FREQUENCY OUTPUT | repair | | | | X | | 11,12 | |
| | rebuild | | | | | X | 11,12 | |
| TURRET ASSEMBLY | repair | | | | X | | 11,12 | |
| | rebuild | | | | | X | 11,12 | |
| SEGMENT ASSEMBLY | replace | | | | X | | | |
| | repair | | | | X | | 11,12 | Repair to the extent of replacing capacitors and resistors |
| CONVERTER, FREQUENCY, ELECTRONIC CV-1102/URM-85 | repair | | | | X | | 11,12 | |
| | overhaul | | | | | X | 11,12 | |
| AMPLIFIER, INTERMEDIATE FREQUENCY | repair | | | | X | | 11,12 | |
| | rebuild | | | | | X | 11,12 | |
| ATTENUATOR, VARIABLE | repair | | | | X | | 11,12 | |
| | rebuild | | | | | X | 11,12 | |
| CABLE ASSEMBLY, RADIO FREQUENCY | repair | | | | X | | 11,12 | |
| GEAR TRAIN ASSEMBLY | rebuild | | | | | X | 11,12 | |
| PANEL ASSEMBLY | rebuild | | | | | X | 11,12 | |
| CONVERTER, FREQUENCY, ELECTRONIC CV-1103/URM-85 | repair | | | | X | | 11,12 | |
| | overhaul | | | | | X | 11,12 | |
| AMPLIFIER, INTERMEDIATE FREQUENCY | repair | | | | X | | 11,12 | |
| | rebuild | | | | | X | 11,12 | |
| ATTENUATOR, VARIABLE | repair | | | | X | | 11,12 | |
| | rebuild | | | | | X | 11,12 | |
| CABLE ASSEMBLY, RADIO FREQUENCY | repair | | | | X | | 11,12 | |
| GEAR TRAIN ASSEMBLY | rebuild | | | | | X | 11,12 | |
| PANEL ASSEMBLY | rebuild | | | | | X | 11,12 | |
| CONVERTER, FREQUENCY, ELECTRONIC CV-1104/URM-85 | repair | | | | X | | 11,12 | |
| | overhaul | | | | | X | 11,12 | |
| AMPLIFIER, INTERMEDIATE FREQUENCY | repair | | | | X | | 11,12 | |
| | rebuild | | | | | X | 11,12 | |
| ATTENUATOR, VARIABLE, INTERMEDIATE FREQUENCY | repair | | | | X | | 11,12 | |
| | rebuild | | | | | X | 11,12 | |
| CABLE ASSEMBLY, RADIO FREQUENCY | repair | | | | X | | 11,12 | |
| GEAR TRAIN ASSEMBLY | rebuild | | | | | X | 11,12 | |
| PANEL ASSEMBLY | rebuild | | | | | X | 11,12 | |
| | | | | | | | | |

| (1) | (2) | (3) | (4) | (5) | (6) | (7) | (8) | (9) |
|---|-------------------------|------------|------------|------------|------------|------------|-------------------|---|
| PART OR COMPONENT | MAINTENANCE FUNCTION | 1ST ECH | 2ND ECH | 3RD ECH | 4TH ECH | 5TH ECH | TOOLS REQUIRED | REMARKS |
| AN/URM-85 (continued) | | | | | | | | |
| CORD ASSEMBLY, ELECTRICAL | repair | | | | X | | 11,12 | |
| COUPLER, ANTENNA (Except CU-895/URM-85) | repair | | | | X | | 11,12 | |
| | rebuild | | | | | X | 11,12 | |
| COUPLER, RADIO FREQUENCY INTERFERENCE | repair | | | | X | | 11,12 | |
| HEADSET, ELECTRICAL H-113/U | | | | | | | | See Separate MAC |
| MULTIMETER, REMOTE ME-204/URM-85 | repair | | | | X | | 11,12 | |
| RECEIVER, RADIO R-1040/URM-85 | repair | X | | | | | 14 | 1st echelon repair is limited to replacement of running spare items including tubes V702,V703,V708,V709. 2nd echelon repair also includes replacement of knobs and tube shields |
| | rebuild | | | | | X | 11,12 | |
| ATTENUATOR, VARIABLE | replace | | | | X | | | |
| | rebuild | | | | | X | 11,12 | |
| CABLE ASSEMBLY, RADIO FREQUENCY | repair | | | | X | | 11,12 | |
| FILTER, RADIO INTERFERENCE | repair | | | | X | | 11,12 | |
| FILTER ASSEMBLY, RADIO FREQUENCY | repair | | | | X | | 11,12 | |
| GENERATOR, IMPULSE NOISE | replace | | | | X | | | |
| | rebuild | | | | | X | 11,12 | |
| REGULATOR, VOLTAGE | repair | | | | X | | 11,12 | |
| REFLECTOR, ANTENNA AT-1027/URM-85 | repair | | X | | X | | 14 11,12 | 2nd echelon repair is limited to replacement of thumbscrews |
| TRANSFORMER, POWER, ISOLATION AND STEP-DOWN TF-248/G | repair | | X | | X | | 14 11,12 | 2nd echelon repair is limited to replacement of fuse and connectors |
| | rebuild | | | | | X | 11,12 | |

Section III. ALLOCATION OF TOOLS FOR MAINTENANCE FUNCTIONS

| (1) TOOLS REQUIRED FOR MAINTENANCE FUNCTIONS | (2) 1ST ECH | (3) 2ND ECH | (4) 3RD ECH | (5) 4TH ECH | (6) 5TH ECH | (7) TOOL CODE | (8) REMARKS |
|--|-------------------|-------------------|-------------------|-------------------|-------------------|---------------------|----------------------|
| AN/URM-85 (continued) | | | | | | | |
| CRYSTAL RECTIFIER TEST SET TS-268/U | | | | + | + | 1 | |
| GENERATOR, PULSE (Empire Devices Model IG-115) | | | | + | + | 2 | To be nomen and std. |
| GENERATOR, SIGNAL AN/URM-49 | | | | + | + | 3 | |
| MULTIMETER TS-352/U | | | | + | + | 4 | |
| MULTIMETER METER ME-26/U | | | | + | + | 5 | |
| OSCILLOSCOPE AN/USM-50 | | | | + | + | 6 | |
| RF SIGNAL GENERATOR SET AN/URM-25 | | | | + | + | 7 | |
| SIGNAL GENERATOR TS-497/URR | | | | + | + | 8 | |
| TEST SET, ELECTRON TUBE TV-2/U | | | | | + | 9 | |
| TEST SET, ELECTRON TUBE TV-7/U | | | | + | | 10 | |
| TOOL KIT TK-87/U | | | | + | + | 11 | |
| TOOL KIT TK-88/U | | | | + | + | 12 | |
| VOLTMETER METER ME-30/U | | | | + | + | 13 | |
| TOOLS AND TEST EQUIPMENT NORMALLY AVAILABLE TO THE USER BECAUSE OF HIS ASSIGNED MISSION | + | + | | | | 14 | |
| | | | | | | | |

APPENDIX III

BASIC ISSUE ITEMS LIST

Section I. INTRODUCTION

1. General

This appendix lists items supplied for initial operation and for running spares. The list includes tools, accessories, parts, and material issued as *part of* the major end item. The list includes all items authorized for basic operator maintenance of the equipment. End items of equipment are issued on the basis of allowances prescribed in equipment authorization tables and other documents that are a basis for requisitioning.

2. Columns

a. Source, Maintenance, and Recoverability Code. Not used.

b. Federal Stock Number. This column lists the n-digit Federal stock number. In the absence of a Federal stock number, an interim number, for example †† L1Se14-426 in the description column indicates that a Federal stock number is being processed for assignment. The L number may be used in emergencies to identify items.

c. Designation by Model. Not used.

d. Description. Nomenclature or the standard item name and brief identifying data for each item are listed in this column. When requisitioning, enter the nomenclature and description on the requisition slip.

e. Unit of Issue. The unit of issue is the supply term by which the individual item is counted for procurement, storage, requisitioning, allowances, and issue purposes.

f. Expendability. Expendable items are indicated by the letter X; nonexpendable items are indicated by NX.

g. Quantity Authorized. Under "Items Comprising an Operable Equipment", the column lists the quantity of items supplied for the initial operation of the equipment. Under "Running Spares and Accessory Items", the quantities listed are those issued initially with the equipment as spare parts. The quantities are authorized to be kept on hand by the operator for maintenance of the equipment.

h. Illustrations. The "Figure No." column lists the figure numbers used for identification of the items in the "Description" column. The "Item No." column is not used.

Section II. FIRST ECHELON FUNCTIONAL PARTS LIST

| (1) | | | (2) | | | (3) | | | (4) | | | (5) | (6) | (7) | (8) | | (9) | | |
|--|-------------------------|----------------------------|--|--|--|------------------|---------------|------------------------|---------------|------------|--|-----|-----|-----|-----|--|-----|--|--|
| SOURCE MAINTENANCE AND RECOVERABILITY CODE | FEDERAL STOCK NUMBER | DESIGNATION BY MODEL | DESCRIPTION | | | UNIT OF ISSUE | EXPENDABILITY | QUANTITY AUTHORIZED | ILLUSTRATIONS | | | | | | | | | | |
| | | | | | | | | | FIGURE NO | ITEM NO | | | | | | | | | |
| | 6625-776-0895 | | RADIO INTERFERENCE MEASURING SET AN/URM-85 | | | | | | | | | | | | | | | | |
| | | | ITEMS COMPRISING AN OPERABLE EQUIPMENT | | | | | | | | | | | | | | | | |
| | | | RADIO INTERFERENCE MEASURING SET AN/URM-85: 150 kc to 1000 mc; 4 converter freq, electronic covering discrete bands; converter No. 1-6 channels, No. 2-2 channels, No. 3-1 channel, No. 4-2 channels; vacuum tube voltmeter indicator 0.5 to 10 mv and -6 to +20 db range; 50 ohm input imped; 115 v, 50 to 400 cyc, 1 ph oper | | | | | | | | | | | | | | | | |
| | Order thru AGC | | TECHNICAL MANUAL TM11-6625-351-12 | | | ea | X | 2 | | | | | | | | | | | |
| | 6625-732-4092 | | RADIO INTERFERENCE MEASURING SET AN/URM-85 (BASIC COMPONENT) | | | ea | NX | 1 | | | | | | | | | | | |
| | | | ALIGNMENT TOOL: 2 working ends, SS; 4-3/8 in lg x 3/8 in across flats; Empire Devices part No. A-6498 | | | ea | X | 1 | 5 | | | | | | | | | | |
| | 6625-731-7906 | | ANTENNA AS-1158/URM-85: cone type; 150 kc to 1000 mc freq range; pedestal mtd; omnidirectional; mounts on reflector for use | | | ea | NX | 1 | 4 | | | | | | | | | | |
| | 6625-752-6098 | | ANTENNA AT-1026/URM-85: loop ant; 150 kc to 30 mc freq range; rotating type; pedestal mtd | | | ea | NX | 1 | 3 | | | | | | | | | | |
| | 6625-752-6097 | | ANTENNA AT-1030/URM-85: straight dipole; 400 mc to 1000 mc freq range; incl corner reflector for 10 db gain increase; pedestal mtd; fixed | | | ea | NX | 1 | 1 | | | | | | | | | | |
| | 6625-752-6094 | | ANTENNA ELEMENT AT-1028/URM-85: dipole arm; resonates over 200 mc-400 mc range cylindrical; 1 end threaded; 0.295 in dia x 6-1/8 in lg; extends to 14-7/8 in lg | | | ea | X | 2 | 4 | | | | | | | | | | |
| | 6625-752-6096 | | ANTENNA ELEMENT AT-1029/URM-85: dipole arm; resonates over 78 mc to 220 mc range cylindrical; 1 end threaded; 1/2 in dia x 12-1/4 in lg; extends to 42-1/8 in lg | | | ea | X | 2 | 4 | | | | | | | | | | |
| | 5905-731-7922 | | ATTENUATOR, FIXED CN-721/URM-85: resistive type; 50 ohm imped; 2 w; 150 kc to 1000 mc freq response; 40 db ± 1/2 db; 2 connectors; 3/5 in lg x 13/16 in dia | | | ea | X | 1 | 5 | | | | | | | | | | |
| | 6625-731-7908 | | BAG, CANVAS CW-572/URM-85: accom Tripod, Antenna MT-2459/URM-85; has adj shoulder strap; 7 in dia x 45 in lg | | | ea | X | 1 | 5 | | | | | | | | | | |
| | 5995-753-2210 | | CABLE ASSEMBLY, POWER, ELECTRICAL CX-6680/U (6 ft): 600 v; 3 cond; 1 plug on ea end; alligator clip on 1 end | | | ea | X | 1 | 5 | | | | | | | | | | |
| | 6625-731-7915 | | CABLE ASSEMBLY, SPECIAL PURPOSE, ELECTRICAL, BRANCHED CX-6681/URM-85: 2 ft 6 in lg o/a | | | ea | X | 1 | 5 | | | | | | | | | | |

| (1) SOURCE MAINTENANCE AND RECOVERABILITY CODE | (2) FEDERAL STOCK NUMBER | (3) DESIGNATION BY MODEL | (4) DESCRIPTION | (5) UNIT OF ISSUE | (6) EXPENDABILITY | (7) QUANTITY AUTHORIZED | (8) ILLUSTRATIONS | |
|---|--------------------------------|-----------------------------------|--|-------------------------|----------------------|-------------------------------|----------------------|------------|
| | | | | | | | FIGURE NO | ITEM NO |
| | | | AN/URM-85 (continued) | | | | | |
| | 6625-753-2166 | | CABLE ASSEMBLY SET, ELECTRICAL MX-3410/URM-85: color coded green and red; one cable feeds output of impulse gen from receiver to ant, other cable feeds incoming RF signal to receiver input | ea | X | 1 | 5 | |
| | 5820-472-1045 | | CASE, ELECTRONIC FREQUENCY CONVERTER CY-3092/URM-85: accom Converter, Frequency Electronic; air valve and handle on top; 12-1/4 in lg x 12-1/2 in wd x 16-7/8 in h | ea | NX | 3 | | |
| | 6625-753-2167 | | CASE, RADIO INTERFERENCE MEASURING SET GROUP CY-3094/URM-85: accom 1 ea Antenna AT-1026/URM-85, 1 ea Coupler, Antenna CU-890/URM-85, 1 ea Probe MX-3409/URM-85, 1 ea Coupler CU-891/URM-85, 1 ea Coupler CU-892/URM-85; 1 handle and 1 air valve on top; 23-7/8 in lg x 8-1/8 in wd x 15-1/4 in h o/a | ea | NX | 1 | 3 | |
| | 6625-753-2208 | | CASE, RADIO INTERFERENCE MEASURING SET GROUP CY-3095/URM-85: accom Antennae, Couplers, Antenna elements, mast sect, cord assys, cable assys, multimeters, measuring tape, ruler, attenuator, headsets, ground rods, transformer, probes, alignment tool, socket, head screw; 26-5/8 in lg x 26-5/8 in wd x 16-7/8 in h o/a | ea | NX | 1 | | |
| | 5820-752-6106 | | CASE, RECEIVER CY-3093/URM-85: accom Receiver, Radio R-1040/URM-85; 1 handle ea side; air valve 1 side; accom 4 legs; 27-1/2 in lg x 13-1/2 in wd x 20-3/8 in h o/a | ea | NX | 1 | 1 | |
| | 5820-752-6102 | | CONVERTER, FREQUENCY, ELECTRONIC CV-1101/URM-85: 150 kc to 30 mc incoming freq range; 455 kc to 1.6 mc resultant freq range; 6.3 v, 50 to 400 cyc, 1 ph; 18.5 v, 105 v, 150 v dc; 50 ohm input, 200 ohm output; 6 bands; 14-1/8 in lg x 9-1/16 in wd x 9 in h o/a | ea | NX | 1 | 6 | |
| | 5820-752-6103 | | CONVERTER, FREQUENCY, ELECTRONIC CV-1102/URM-85: 20 mc to 220 mc incoming freq range; 10.7 mc resultant freq; 6.3 v, 50 to 400 cyc, 1 ph; 18.5 v, 105 v, 150 v dc; 50 ohm input, 200 ohm output; 2 bands; 14-1/8 in lg x 9-1/16 in wd x 9 in h o/a | ea | NX | 1 | 2 | |
| | 5820-752-6104 | | CONVERTER, FREQUENCY, ELECTRONIC CV-1103/URM-85: 200 mc to 400 mc incoming freq range; 30 mc resultant freq; 6.3 v, 50 to 400 cyc, 1 ph; 18.5 v, 105 v, 150 v dc; 5 ohm input, 200 ohm output; 1 tuneable band; 14-1/8 in lg x 9-1/16 in wd x 9 in h o/a | ea | NX | 1 | 6 | |
| | 5820-752-6105 | | CONVERTER, FREQUENCY, ELECTRONIC CV-1104/URM-85: 400 mc to 1000 mc incoming freq range; 42 mc resultant freq; 6.3 v, 50 to 400 cyc, 1 ph; 18.5 v, 105 v, 150 v; 50 ohm input, 200 ohm output; 2 bands; 14-1/8 in lg x 9-1/16 in wd x 9 in h o/a | | | | | |

| (1) SOURCE MAINTENANCE AND RECOVERABILITY CODE | (2) FEDERAL STOCK NUMBER | (3) DESIGNATION BY MODEL | (4) DESCRIPTION | (5) UNIT OF ISSUE | (6) EXPENDIBILITY | (7) QUANTITY AUTHORIZED | (8) ILLUSTRATIONS | |
|---|--------------------------------|-----------------------------------|--|-------------------------|----------------------|-------------------------------|----------------------|------------|
| | | | | | | | FIGURE NO | ITEM NO |
| | | | AN/URM-85 (continued) | | | | | |
| | 6625-752-6099 | | COUPLER, ANTENNA CU-890/URM-85: 150 kc to 30 mc in 6 bands; transformer coupling; 1 w max; variable tuning; 2 connector type. 8-1/2 in lg x 5 in dia | ea | X | 1 | 3 | |
| | 5995-196-9564 | | CORD ASSEMBLY, ELECTRICAL: 2 cond, stranded; tp plug one end, tp jack other end; 5 ft 10-13/32 in lg o/a; MIL type CD-307-A | ea | X | 2 | 5 | |
| | 6625-557-7475 | | CORD ASSEMBLY, ELECTRICAL CD-307 (30 ft): 2 cond, stranded; tp plug one end, tp jack other end; 30 ft lg o/a; MIL type CD-307-A | ea | X | 1 | 5 | |
| | 6625-557-8632 | | CORD ASSEMBLY, ELECTRICAL CX-4305/U (30 ft): f/remote meter | ea | X | 1 | 5 | |
| | 6625-752-6100 | | COUPLER, ANTENNA CU-893/URM-85: transformer coupling; 20 mc to 200 mc freq range; 1 w max; transforms balanced line to unbalanced line; accom 2 dipole ant elements; pedestal mtd; 24-1/8 in lg x 3-1/8 in wd x 2-3/4 in d | ea | X | 1 | 4 | |
| | 6625-752-6101 | | COUPLER, ANTENNA CU-894/URM-85: transformer coupling; 200 to 400 mc freq range; 1 w max; transforms balanced line to unbalanced line; accom 2 dipole ant elements; pedestal mtd; 24-1/8 in lg x 3-1/8 in wd x 2-3/4 in d o/a | ea | X | 1 | 4 | |
| | 6625-731-7910 | | COUPLER, ANTENNA CU-895/URM-85: resistive coupling; 150 kc to 1000 mc freq range; 1 w max; fixed tuning; 3 connectors, 3-3/4 in lg x 3-1/4 in wd x 1-1/4 in h o/a | ea | X | 1 | 4 | |
| | 6625-731-7912 | | COUPLER, RADIO FREQUENCY INTERFERENCE CU-891/URM-85: u/w 150 kc to 300 mc freq range; couples rf energy from 50 ohm transmission line to AN/URM-85 input; incl 2 ea connector UG-58A/U and 2 bind posts; 2-1/2 in lg x 2-3/8 in dia | ea | X | 1 | 3 | |
| | 6625-731-7911 | | COUPLER, RADIO FREQUENCY INTERFERENCE CU-892/URM-85: used w/150 kc to 30 mc freq range; couples rf energy from 500 ohm transmission line to AN/URM-85 input; incl 2 connectors UG-58A/U and 2 bind posts; 2-1/2 in lg x 2-3/8 in dia | ea | X | 1 | 3 | |
| | 6625-731-7916 | | COUPLER, RADIO FREQUENCY INTERFERENCE CU-896/URM-85: couples rf energy from 50 ohm transmission lines to AN/URM-85 input; used in 20 mc to 1000 mc freq range; 1 conn, 2 bind posts; 2-1/2 in lg x 2-3/8 in dia | ea | X | 1 | 4 | |
| | 6625-731-7917 | | COUPLER, RADIO FREQUENCY INTERFERENCE CU-897/URM-85: couples rf energy from 500 ohm transmission lines to AN/URM-85 input; 20 mc to 1000 mc freq range; incl 1 conn, 2 bind posts; 2-1/2 in lg x 2-3/8 in dia | ea | X | 1 | 4 | |
| | 5965-504-6370 | | HEADSET, ELECTRICAL H-113/U | ea | NX | 1 | 5 | |
| | | | KEY, SOCKET HEAD SCREW: hex; "L" handle; 3/64 in across handle; 1-9/16 in lg x 15/32 in d; Fed type I, class A ++L1Sel4-425 | ea | X | 1 | | |
| | | | KEY, SOCKET HEAD SCREW: hex; "L" handle; 1/16 in across flats; 1-21/32 in lg x 15/32 in d; Fed type I, Class A ++L1Sel4-426 | ea | X | 1 | | |
| | | | KEY, SOCKET HEAD SCREW: hex; "L" handle; 5/64 in across flats; 1-25/32 in lg x 33/64 in d; Fed type I, class A ++L1Sel4-427 | ea | X | 1 | | |

| (1) SOURCE MAINTENANCE AND RECOVERABILITY CODE | (2) FEDERAL STOCK NUMBER | (3) DESIGNATION BY MODEL | (4) DESCRIPTION | (5) UNIT OF ISSUE | (6) EXPENDABILITY | (7) QUANTITY AUTHORIZED | (8) ILLUSTRATIONS | |
|---|--------------------------------|-----------------------------------|--|-------------------------|----------------------|-------------------------------|----------------------|------------|
| | | | | | | | FIGURE NO | ITEM NO |
| | | | AN/URM-85 (continued) | | | | | |
| | | | KEY, SOCKET HEAD SCREW: hex; "L" handle; 3/32 in across flats; 1-29/32 in lg x 9/16 in d; Fed type I, Class A ++L1Sel4-426 | ea | X | 1 | | |
| | | | LEG, CASE: telescoping leg u/w case, Receiver CY-3093/URM-85; alum; 1-1/8 in dia x 24 in lg; extends to 31 in lg ++L1Sel4-437 | ea | X | 4 | 1 | |
| | 5820-228-0244 | | MAST SECTION AB-21/GR | ea | X | 12 | 5 | |
| | 6625-731-7914 | | MULTIMETER, REMOTE ME-204/URM-85: upper scale -6 to +20 db, lower scale 0 to 10 mv; for use up to 30 ft from end item equip; c/o meter, connector, tp jack incl in alum housing | ea | NX | 1 | 5 | |
| | 6625-753-2157 | | PROBE, ELECTRICAL FIELD INTERFERENCE MEASURING MX-3411/URM-85: 150 kc to 1000 mc freq range; 50 ohm; 8 in lg x 7/8 in dia | ea | X | 1 | 5 | |
| | 6625-753-2156 | | PROBE, MAGNETIC FIELD, INTERFERENCE MEASURING MX-3412/URM-85: 20 mc to 1000 mc freq range; 50 ohm; 1 female connector; 9 in lg x 3-3/8 in dia | ea | X | 1 | 4 | |
| | 6625-753-2155 | | PROBE, MAGNETIC FIELD, INTERFERENCE MEASURING MX-3409/URM-85: 150 kc to 30 mc; 50 ohm; vinyl jacket covering; 1 female connector; 9 in lg x 3-3/8 in dia | ea | NX | 1 | 3 | |
| | 5820-752-6108 | | RECEIVER, RADIO R-1040/URM-85: 150 kc to 1000 mc, 11 bands; 600 ohm imped; 115 v or 230 v, 50 to 400 cyc, 1 ph, accom 1 of 4 converters; 21-3/8 in lg x 15-3/4 in d x 10-3/16 in h | ea | NX | 1 | 2 | |
| | 6625-752-6095 | | REFLECTOR, ANTENNA AT-1027/URM-85: plane type; u/w cone ant and vert ant coupler units; mts on tripod base; 24 in lg x 24 in wd x 1-1/4 in h o/a | ea | X | 1 | 4 | |
| | 5975-578-4777 | | ROD, GROUND GP-117/URM-7: w/handle; 12 in lg x 3/8 in dia o/a | ea | X | 1 | 3 | |
| | 7510-732-1642 | | RULER, PLASTIC: calibrations on 1 side indicate correct lg of dipole arms for desired freq; other side indicates spacing required between dipole and reflector: 12 in lg x 1-3/8 in wd; Empire Devices part No. D-3895 | ea | X | 1 | 4 | |
| | | | TAPE, MEASURING: steel; graduated in units of megacycles from 17 mc thru 400 mc; hand crank rewind; 1/2 in wd tape; measures dipole arm freq; Empire Devices part No. A-6277 ++L1Sel4-33 | ea | X | 1 | 4 | |
| | 5950-566-3753 | | TRANSFORMER, POWER, ISOLATION AND STEP-DOWN TF-248/G: | ea | NX | 1 | 5 | |
| | 6625-735-6476 | | TRAY, ACCESSORY: alum; w/hinged cover; accom 1 gnd rod; 4 keys, socket head screw in cover and 1 fixed attenuator, 2 antenna elements, 1 steel tape, 3 couplers, 2 probes, 1 ruler, 1 alignment tool in bottom unit 13 in lg x 9/14 in d x 3-1/8 in h o/a | ea | X | 1 | | |
| | 6625-731-7907 | | TRIPOD, ANTENNA MT-2459/URM-85: mts ant or ant reflectors; incl 3 mast sect; has 3 adj wooden legs; 5-1/2 in dia x 3 ft lg; extends to 5 ft lg | ea | X | 1 | 1 | |

| (1) | | | (2) | | (3) | | | (4) | (5) | (6) | (7) | (8) | | (9) |
|--|--|--|-------------------------|--|----------------------------|--|--|--|------------------|---------------|------------------------|---------------|------------|-----|
| SOURCE MAINTENANCE AND RECOVERABILITY CODE | | | FEDERAL STOCK NUMBER | | DESIGNATION BY MODEL | | | DESCRIPTION | UNIT OF ISSUE | EXPENDABILITY | QUANTITY AUTHORIZED | ILLUSTRATIONS | | |
| | | | | | | | | | | | | FIGURE NO | ITEM NO | |
| AN/URM-85 (continued) | | | | | | | | | | | | | | |
| RUNNING SPARES AND ACCESSORY ITEMS | | | | | | | | | | | | | | |
| | | | 5960-503-4880 | | | | | ELECTRON TUBE: MIL type OACWA | ea | X | 1 | 7 | | |
| | | | 5960-262-3763 | | | | | ELECTRON TUBE: MIL type OB2WA | ea | X | 1 | 7 | | |
| | | | 5960-166-7663 | | | | | ELECTRON TUBE: MIL type 12AU7 | ea | X | 1 | 7 | | |
| | | | 5960-262-0210 | | | | | ELECTRON TUBE: MIL type 5814A | ea | X | 1 | 7 | | |
| | | | 5920-296-4164 | | | | | FUSE, CARTRIDGE: slo-blo MIL type FO2D2ROOB | ea | X | 5 | 7 | | |
| | | | 6240-155-8706 | | | | | LAMP, INCANDESCENT: MIL type MS15571-2 | ea | X | 1 | 7 | | |
| | | | 6110-573-3829 | | | | | REGULATOR, VOLTAGE: 100 v to 130 v ac input, 1 amp, ±2% regulation; encl; socket mtd; 2, in lg x 1-9/16 in wd x 1-13/16 in h excl term; Electric Regulator Corp part No. VTX10 | ea | X | 1 | 7 | | |

GLOSSARY

Section I. ABBREVIATIONS

| | | | |
|---------------|---|------------|---|
| bw | bandwidth | SERIES CAL | series calibration operation, used with discone (broadband), loop, and vertical antennas |
| CW AVERAGE | continuous -wave signal, average envelope detection | | |
| CW PEAK | continuous -wave signal, peak envelope detection | SHUNT CAL | shunt calibration operation, used with dipole antennas, probes, and conductive couplers |
| ext | external | | |
| GND | ground potential binding post on conductive coupler | SUBST. | substitute |
| HI | high potential binding post on conductive coupler | UV | microvolt |
| kc | kilocycle | uv/mc | microvolt per megacycle |
| MOM. | momentary | | |
| 0 CW ONLY | zero attenuation, for reception of continuous-wave signals only | ZERO ADJ. | zero adjust position of function switch; also used as zero adjust control for setting the meter pointer to 0 db at the start of operating procedures. |
| 0 SUBST. ONLY | zero attenuation, for use with the substitution method of operation | | |

Section II. DEFINITIONS OF UNUSUAL TERMS

Attenuation — The process of reducing the amplitude of rf signals in preset ratios by insertion of resistive losses.

Balun — A balanced-to-unbalanced transformation which converts the two coaxial terminations from each arm of a dipole antenna into a single coaxial termination. In this test set, the two coaxial terminations are at the antenna end of the bakelite tube that supports the dipole; the single coaxial termination is the N-type receptacle at the opposite end of the balun.

Bandwidth — The numerical difference between the highest and lowest frequencies passed by an electrical circuit.

Broadband signal — A radio signal having a spectrum which is wider than the pass-

band of the receiver or other instrument under test. Broadband interference is usually produced by switching transients in electronic and electrical equipment, and consists of short-duration pulses that have either a regular or random repetition rate.

Conductive coupler — A device that has appropriate electrical connectors to enable the direct coupling of broadband interference, which may be present on powerlines or audio-signal lines, to the main unit of the test set.

Corner reflector and dipole antenna — The signal pickup device used over the frequency range from 400 to 1,000 mc. This device is an integral assembly of balun, dipole antenna, and antenna reflector.

By proper spacing of the r e f l e c t o r with respect to the actual dipole arms, a gain of 10 db with respect to the dipole antennas for tuning units 2 and 3 is achieved.

Dipole antenna — A device for picking up radiated rf signals by two lengths of conductive material. In this test set, the end arm of each dipole is of telescopic construction, so that the length of the arm can be adjusted to resonate with the frequency of the incoming signal.

Discone (broadband) antenna — A conical structure having three sockets at its curved end for accepting Mast Sections AB-21/GR, and a tapered threaded connector at its base end for accepting the noncolor-coded connector of the unbalanced injection block. This antenna is omnidirectional and covers the broad frequency range from 20 to 1,000 mc when the proper number of mast sections are inserted into the cone sockets.

External transformer — A device that may be connected to either a 120-or 240-volt ac, 50- to 400-cps power source. Input potentials of 240 volts are stepped down to an output of 120 volts, which is the voltage required for operation of the test set.

Ground plane — A rectangular metal plate used with the discone (broadband) and vertical antennas as an artificial ground (counterpoise).

Impulse generator — An electronic circuit that p r o d u c e s extremely short duration (0.5-millimicrosecond) pulses. The spectral components of the output pulse are flat, over the working frequency range of the test set, from 150 kc to 1,000 mc.

Metered slideback technique — A method of operating the test set so that the audio output of the signal under measurement is reduced to the threshold level of audibility at the same time that the meter also indicates relative signal intensity.

Microvalts - per - megacycle bandwidth — The rms value of a sine wave voltage that produces the same peak response when passed through an amplifier, as coupling a pulse through an idealized amplifier. It is assumed that the fre-

quency of the sine wave voltage is at the center of the pass-band of the amplifier, and that the amplifier has a 1-me bandwidth with a linear phase characteristic.

Microvolt per meter — A value obtained by dividing the potential difference between the receiving antenna system and ground by the distance, in meters, between the two points.

Narrow-band signal — A radio signal having a spectrum that is less than the pass-band of the receiver or other instrument under test. Narrow-band interference is usually a modulated or unmodulated continuous-wave signal, and is produced by undesired output (such as harmonic or parasitic signals) from transmitters or from local oscillator output of signal generators or radio receivers.

Radiofrequency interference — Electrical disturbances that prevent utilizing the maximum sensitivity of radio receiving systems. In this equipment, the term is limited to only man-made interference, such as that produced by electrically operated vehicles, generators, and other electronic or electrical equipment.

Remote meter — An indicating device that duplicates the pointer deflection of the front-panel meter on the main unit when connected to the RECORDER EXT METER jack through the remote meter cord.

Slideback technique — A method of operating the test set so that the audio output of the incoming rf signal and of the internal impulse generator is reduced to the threshold level of audibility in the headset.

Unbalancezd injection block — An electro-mechanical device for converting the single terminal at the base of the discone antenna into a two-terminal connecting point. The two terminals are required for:

- a. Coupling the incoming rf signal or the attenuated signal of the impulse generator from the discone (broadband) antenna to the input of the main unit.
- b. Coupling the output of the impulse generator to the attenuating network that is housed within the unbalanced injection block.

By Order of the Secretary of the Army:

G. H. DECKER,
General, United States Army,
Chief of Staff.

Official:

R. V. LEE,
Major General United States Army,
The Adjutant General.

Distribution:

Active Army:

USASA (2)
DASA (5)
CNGB (1)
Tech Stf, DA (1) except
CSigO (18)
Tech Stf Bd (1)
USCONARC (5)
USAARTYBD (1)
USAARMBD (2)
USAIB (1)
USARADB (2)
USAABELCTBD (1)
USAAVNBD (1)
USAATBD (1)
ARADCOM (2)
ARADCOM, Rgn (2)
OS Maj Comd (3)
OS Base Comd (2)
LOGCOM (2)
USAOMC (3)
MDW (1)
Armies (2)
Corps (5)
Div (2)
USATC (2)
1st GM Bde (5)
Fort Monmouth (71)
Svc Colleges (2)
Br Svc Sch (2)
GENDEP (2) except
Atlanta GENDEP (none)
Sig Sec, GENDEP (5)
Sig Dep (12)
WRAMC (1)

POE (OS) (1)
USA Trans Tml Comd (1)
Army Tml (1)
OSA (1)
USAEPG (2)
Yuma Test Sta (2)
Sig Fld Maint Shops (3)
AFIP (1)
AMS (1)
EMC (1)
Army Pictorial Cen (2)
USASSA (20)
USASSAMRO (1)
USACA (3)
USASEA (1)
USA Msl Spt Agcy (13)
USARCARIB Sig Agcy (1)
USASATSA (5)
JBUSMC (1)
Units org under fol TOE:
(2 copies each UNOINDC)
11-7
11-16
11-57
11-98
11-117
11-155
11-500 (AA-AE) (4)
11-557
11-587
11-592
11-597
33-56

NG: State AG (3).

USAR: None.

For explanation of abbreviations used, see AR 320-50.

RECOMMENDED CHANGES TO EQUIPMENT TECHNICAL PUBLICATIONS



THEN...JOT DOWN THE DOPE ABOUT IT ON THIS FORM. CAREFULLY TEAR IT OUT, FOLD IT AND DROP IT IN THE MAIL.

SOMETHING WRONG WITH PUBLICATION

FROM: (PRINT YOUR UNIT'S COMPLETE ADDRESS)

DATE SENT

PUBLICATION NUMBER

PUBLICATION DATE

PUBLICATION TITLE

BE EXACT PIN-POINT WHERE IT IS

PAGE NO.

PARA-GRAPH

FIGURE NO.

TABLE NO.

IN THIS SPACE, TELL WHAT IS WRONG AND WHAT SHOULD BE DONE ABOUT IT.

TEAR ALONG PERFORATED LINE

PRINTED NAME, GRADE OR TITLE AND TELEPHONE NUMBER

SIGN HERE

The Metric System and Equivalents

Linear Measure

1 centimeter = 10 millimeters = .39 inch
 1 decimeter = 10 centimeters = 3.94 inches
 1 meter = 10 decimeters = 39.37 inches
 1 dekameter = 10 meters = 32.8 feet
 1 hectometer = 10 dekameters = 328.08 feet
 1 kilometer = 10 hectometers = 3,280.8 feet

Weights

1 centigram = 10 milligrams = .15 grain
 1 decigram = 10 centigrams = 1.54 grains
 1 gram = 10 decigrams = .035 ounce
 1 dekagram = 10 grams = .35 ounce
 1 hectogram = 10 dekagrams = 3.52 ounces
 1 kilogram = 10 hectograms = 2.2 pounds
 1 quintal = 100 kilograms = 220.46 pounds
 1 metric ton = 10 quintals = 1.1 short tons

Liquid Measure

1 centiliter = 10 milliliters = .34 fl. ounce
 1 deciliter = 10 centiliters = 3.38 fl. ounces
 1 liter = 10 deciliters = 33.81 fl. ounces
 1 dekaliter = 10 liters = 2.64 gallons
 1 hectoliter = 10 dekaliters = 26.42 gallons
 1 kiloliter = 10 hectoliters = 264.18 gallons

Square Measure

1 sq. centimeter = 100 sq. millimeters = .155 sq. inch
 1 sq. decimeter = 100 sq. centimeters = 15.5 sq. inches
 1 sq. meter (centare) = 100 sq. decimeters = 10.76 sq. feet
 1 sq. dekameter (are) = 100 sq. meters = 1,076.4 sq. feet
 1 sq. hectometer (hectare) = 100 sq. dekameters = 2.47 acres
 1 sq. kilometer = 100 sq. hectometers = .386 sq. mile

Cubic Measure

1 cu. centimeter = 1000 cu. millimeters = .06 cu. inch
 1 cu. decimeter = 1000 cu. centimeters = 61.02 cu. inches
 1 cu. meter = 1000 cu. decimeters = 35.31 cu. feet

Approximate Conversion Factors

| To change | To | Multiply by | To change | To | Multiply by |
|---------------|--------------------|-------------|--------------------|---------------|-------------|
| inches | centimeters | 2.540 | ounce-inches | newton-meters | .007062 |
| feet | meters | .305 | centimeters | inches | .394 |
| yards | meters | .914 | meters | feet | 3.280 |
| miles | kilometers | 1.609 | meters | yards | 1.094 |
| square inches | square centimeters | 6.451 | kilometers | miles | .621 |
| square feet | square meters | .093 | square centimeters | square inches | .155 |
| square yards | square meters | .836 | square meters | square feet | 10.764 |
| square miles | square kilometers | 2.590 | square meters | square yards | 1.196 |
| acres | square hectometers | .405 | square kilometers | square miles | .386 |
| cubic feet | cubic meters | .028 | square hectometers | acres | 2.471 |
| cubic yards | cubic meters | .765 | cubic meters | cubic feet | 35.315 |
| fluid ounces | milliliters | 29.573 | cubic meters | cubic yards | 1.308 |
| pints | liters | .473 | milliliters | fluid ounces | .034 |
| quarts | liters | .946 | liters | pints | 2.113 |
| gallons | liters | 3.785 | liters | quarts | 1.057 |
| ounces | grams | 28.349 | liters | gallons | .264 |
| pounds | kilograms | .454 | grams | ounces | .035 |
| short tons | metric tons | .907 | kilograms | pounds | 2.205 |
| pound-feet | newton-meters | 1.356 | metric tons | short tons | 1.102 |
| pound-inches | newton-meters | .11296 | | | |

Temperature (Exact)

| | | | | |
|----|-------------|-----------------|-------------|----|
| °F | Fahrenheit | 5/9 (after | Celsius | °C |
| | temperature | subtracting 32) | temperature | |

PIN: 017146-005